





Push Pull Self-Locking Connector Manufacturer

Shenzhen Renhotec
Technology Electronics Co., LTD

 No 5, Xinyuan North Fifth Road, Ludong Village
Humen Town, Dongguan, 523939, Guangdong

 Tel: (86)-769-81100186
 Fax: (86)-769-81875836

 sale@renhotec.com

Renhao Weiye Technology
(Wuhan) Co., LTD

 No 555, Wenhua Avenue, Hongshan District
430014, Wuhan, Hubei Province

 www.renhotec.com
www.renhotecpro.com

 Online shop: www.elecbee.com

RENHOTEC GROUP CO., LTD

Table of contents

B series 05-16

Description:
Push pull self locking, IP50, Omni-directional shielding, a variety of positioning pins, multi-color recognition.

Characteristics:
Multi-contact (2-32 contacts), mixed loading needle contact, electrical mixing, photoelectric mixing, high pressure, single/multi-coaxial, single/multi-gas path, vacuum seal.

Series: 00B, 0B, 1B, 2B, 3B, 3.5B, 4B.

Size: M7, M9, M12, M15, M18, M20.

[More...](#)



K series 17-23

Description:
Push pull self locking, IP66/IP68, waterproof, Omni-directional shielding, a variety of positioning pins, multi-color recognition.

Characteristics:
Multi-contact (2-32 contacts), mixed loading needle contact, electrical mixing, photoelectric mixing, high pressure, single/multi-coaxial, single/multi-gas path, vacuum seal.

Series: 0K, 1K, 2K, 3K, 4K, 5K.

Size: M14, M16, M20, M24, M30, M45.

[More...](#)



S series 24-29

Description:
Push pull self locking, IP50, Omni-directional shielding, half moon type insulation contact positioning, multi-color recognition.

Characteristics:
Single contact, multi-contact, mixed loading needle contact, photoelectric mixed loading, high voltage, single/multi-coaxial.

Series: 00S, 0S, 1S, 2S, 3S.

Size: M7, M9, M12, M15, M18.

[More...](#)



F series 30-35

Description:
Push pull self locking, IP66/IP68, waterproof, Omni-directional shielding, a variety of positioning pins, multi-color recognition.

Characteristics:
Multi-contact (2-32 contacts), mixed loading needle contact, photoelectric mixing, high pressure, vacuum seal.

Series: 0F, 1F, 1.5F, 2F, 3F.

Size: M9, M14, M16, M18.

[More...](#)



Table of contents

P series 36-46

Description:
Push pull self locking, IP50, a variety of positioning pins, multi-color recognition.

Characteristics:
Multi-contact (2-32 contacts), mixed loading needle contact, electrical mixing, photoelectric mixing, single/multi-gas path.

Series: 0P, 1P, 2P.

Size: M10, M14, M17.

[More...](#)



W series 47-50

Description:
Screw coupling system, IP68, underwater, Omni-directional shielding, a variety of positioning pins, multi-color recognition.

Characteristics:
Multi-contact (2-32 contacts), mixed loading needle contact, electrical mixing, photoelectric mixing, single/multi-gas path.

Series: 0W, 1W, 2W, 3W.

Size: M12, M14, M16, M20.

[More...](#)



T series 51-54

Description:
Push pull self locking, IP66/68, waterproof, Omni-directional shielding, a variety of positioning pins, multi-color recognition.

Characteristics:
Multi-contact (2-32 contacts), mixed loading needle contact, electrical mixing, photoelectric mixing, high pressure.

Series: 0T, 1T, 2T, 3T.

Size: M9, M12, M15, M18.

[More...](#)



HR10A series 55-60

Description:
Push-pull Self-latching-IP50, Screw coupling-IP65-68, Omni-directional shielding.

Characteristics:
Multi-contact, Mini.

Series: NO.1, NO.2, NO.3.

Size: M8, M11, M14.

[More...](#)



Table of contents

Insert configuration 61-66

Description of the sequence of male and female needle contact stitches.
Description of solder cup matching cable diamete.
Needle contact voltage and current parameters.



PCB drilling pattern 67-72

Fixed socket for printed circuit.
Holes for fixing the housing.
Fixed socket with straight print contact.
Elbow socket (90°) for printed circuit.
Fixed socket with elbow print contact.



Cable assembly 73-74

Cables are fixed into push pull connectors with cable collet systems.
Suitable for B,K,S,P,T,W,F series plugs



Spare parts 75-77

Plug/Socket caps:Dust, Waterproof.
Insulating washers:Sockets or plugs mounted on panels can be fitted with insulating washers. The nine colours available combined with those for the bend reliefs makes colour coding possible.
Bend relief:Different colors can be distinguished.



Table of contents

Plug assembly instructions 78-79

Assembly sequence instruction of plug outer shell,insulator,earthing cone,o-ring,collet and collet nut.



Single contact coaxial connector 80

Protection index (mated):IP 50
The connection method:Push-pull Self-latching
Contact:single contact



Wire harness processing scheme 81-84

Cable harness cable customization processing scheme:
adapter line, power line, DB9, DB15, DB25, DC, DNC, SMA, crocodile clip, cable customization, a multi-point cable production.
Customized processing cable display.



Testing and production equipment 85-86

CNC,
wire harness testing machine,
injection molding machine,
tensile tester,
stripping machine,
winding machine, etc





B series

B series connectors provide the following main features:

- Security of the Push-Pull self-latching system.
- Multipole types 2 to 32 contacts.
- Solder or print contacts (straight or elbow).
- High packing density for space savings.
- Multiple key options to avoid cross mating.
- Keying system («G» key standard) of similar connectors for connector alignment.
- 360° screening for full EMC shielding.

B series metal connector technical characteristics:

- Mechanical and Climatical.
- Endurance: > 5000 cycles.
- Humidity: up to 95% at 60°C.
- Temperature range: - 55°C, + 250°C.
- Resistance to vibrations: 10-2000 Hz, 15g.
- Shock resistance: 100g, 6ms.
- Salt spray corrosion test: > 48h.
- Protection index (mated): IP 50.

Part Numbering System of B series

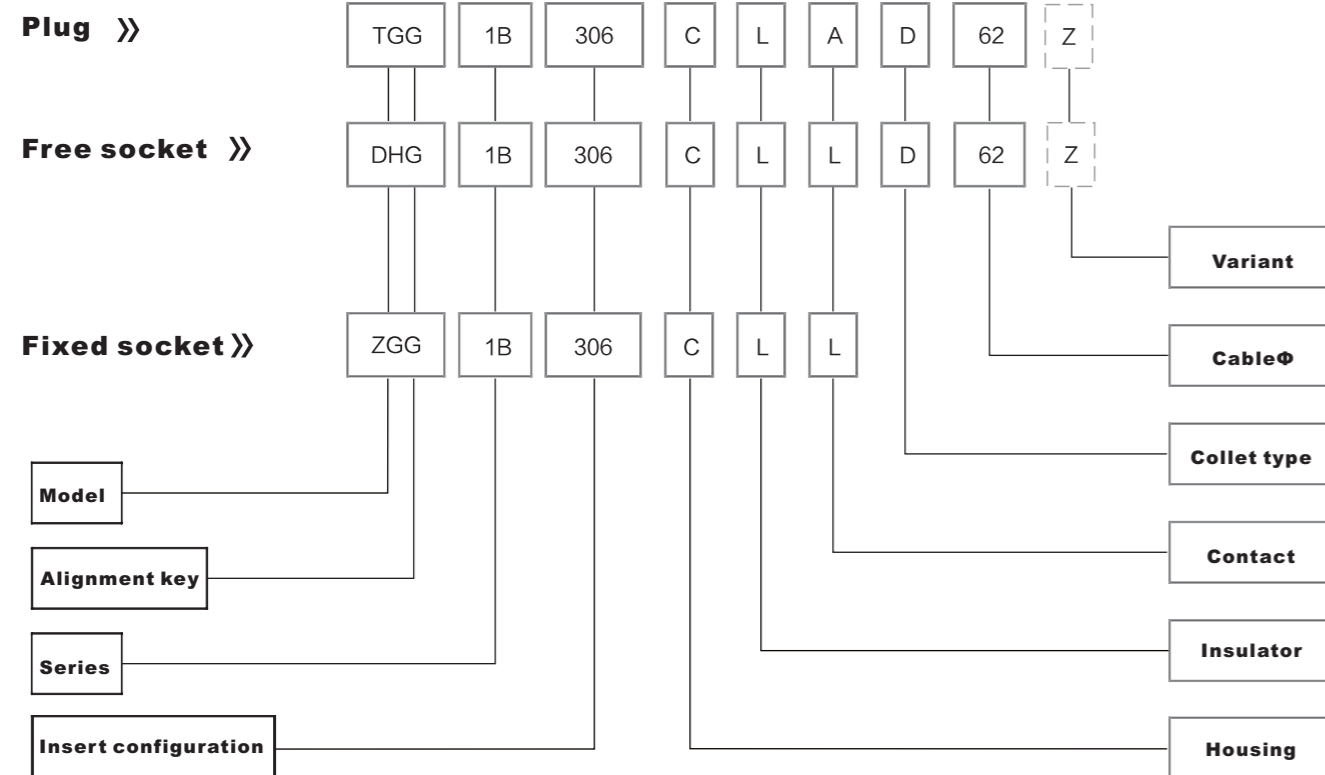

Product appearance and Push-Pull self-latching system

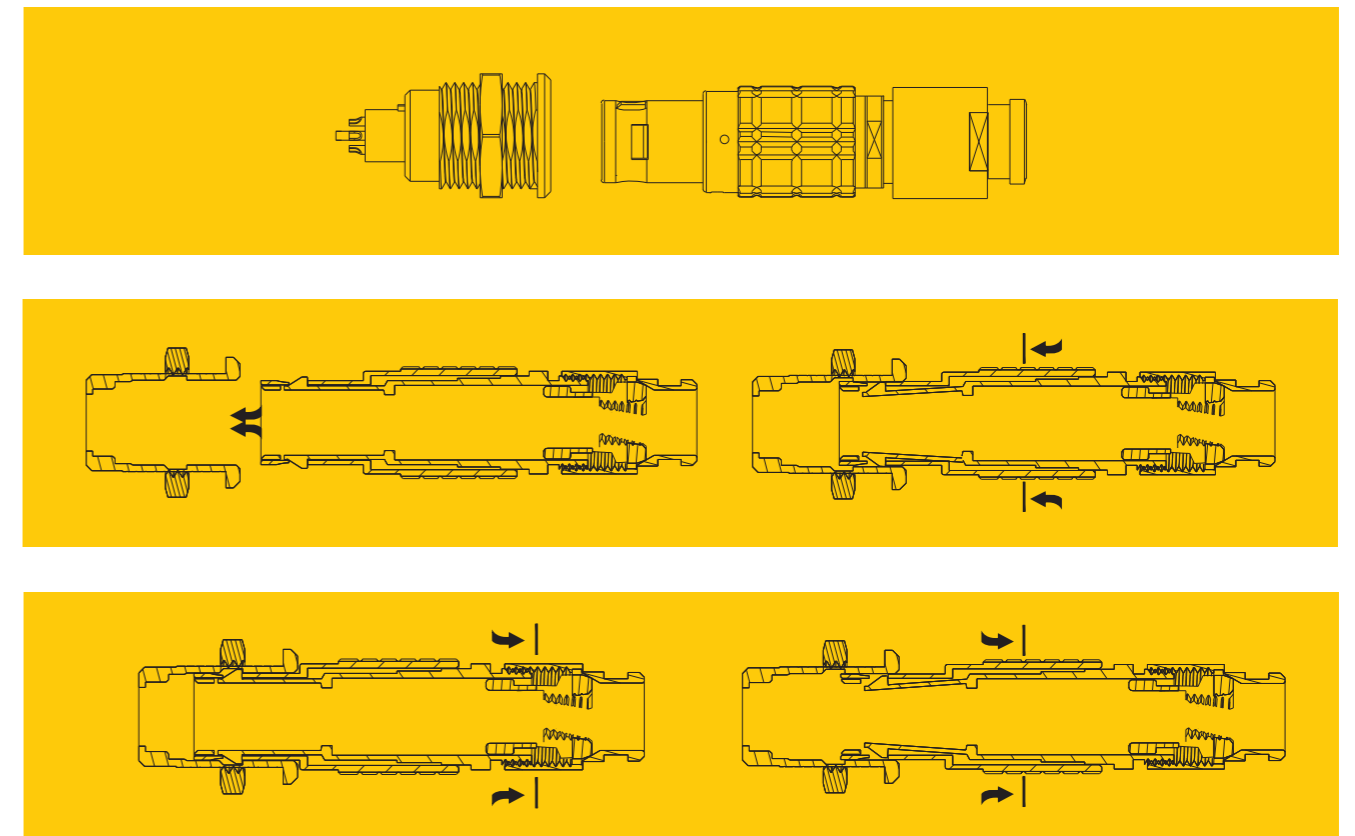

Straight plug with cable collet:

- ▲ TGG.1B.306.CLAD62 = Straight plug with key (G) and cable collet, 1B series, multipole type with 6 contacts, outer shell in chrome-plated brass, PPS insulator, male solder contacts, D type collet for 6.0mm diameter cable.
- ▲ DHG.1B.306.CLLD62Z = Free socket, with key (G), with cable collet, 1B series, multipole type with 6 contacts, outer shell in chrome-plated brass, PPS insulator, female solder contacts, D type collet for 6.0mm diameter cable.
- ▲ ZGG.1B.306.CLL = Fixed socket, nut fixing, with key (G), 1B series, multipole type with 6 contacts, outer shell in chrome-plated brass, PPS extended insulator, female solder contacts.

Part Section Showing Internal Components

Fixed socket

- outer shell
- earthing crown
- retaining ring
- hexagonal nut
- locking washer
- insulator
- female contact

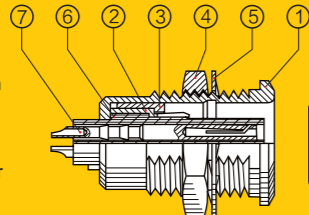

Straight plug

- outer shell
- latch sleeve
- collet nut
- split insert carrier
- insulator
- male contact
- collet

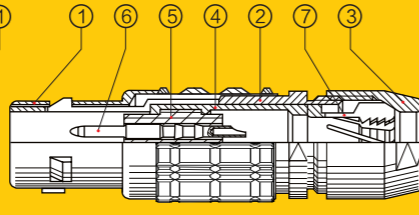

TGG Straight plug

Key (G) or keys (A...M and R), cable collet

Reference	Dimensions (mm)				
Series	Model	A	L	M	C
00B	TGG	6.4	29.0	8.0	5.0
0B	TGG	9.5	36.0	10.0	7.0
1B	TGG	12.0	43.8	11.0	8.9
2B	TGG	15.0	51.0	12.0	12.0
3B	TGG	17.8	61.2	15.0	15.0
4B	TGG	25.0	75.0	18.0	20.0

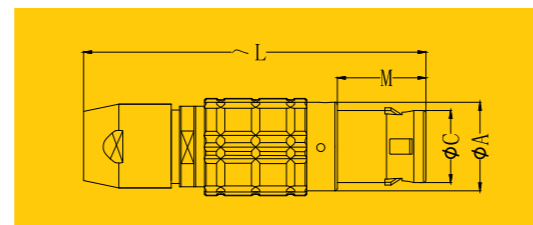

TGG Straight plug

Key (G) or keys (A...M and R), cable collet and nut for fitting a bend relief

Reference	Dimensions (mm)				
Series	Model	A	L	M	C
00B	TGG	6.4	36.0	8.0	5.0
0B	TGG	9.5	39.0	10.0	7.0
1B	TGG	12.0	47.0	11.0	8.9
2B	TGG	15.0	55.5	12.0	12.0
3B	TGG	17.8	64.0	15.0	15.0

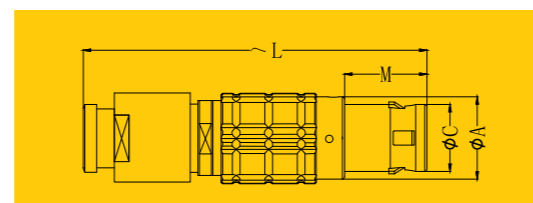
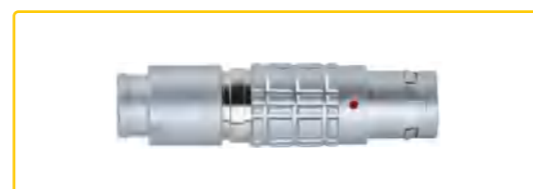

TWG Fixed plug

Nut fixing, key (G) or keys (A...M and R)

Reference	Dimensions (mm)									
Series	Model	A	B	e	E	L	M	N	S1	S3
0B	TWG	13.8	12.4	M9×0.6	2.0	25.3	17.4	22.4	7.8	11.0
1B	TWG	18.0	15.8	M12×1.0	3.0	24.9	17.0	24.8	10.5	14.0
2B	TWG	19.5	19.2	M15×1.0	5.2	28.6	18.0	27.3	13.5	17.0

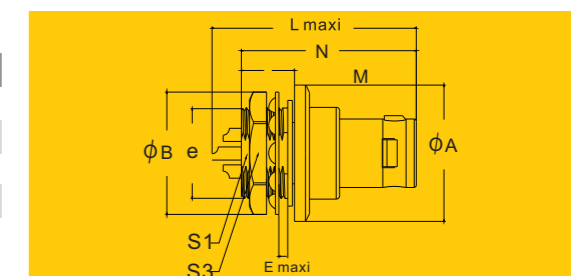

TNG Straight plug

Key (G) or keys (A...M and R), cable collet and lanyard release

Reference	Dimensions (mm)							
Series	Model	A	B	L	M	N	S1	S2
0B	TNG	9.5	15.5	36.0	26.0	140	9.0	8.0
1B	TNG	12.0	18.0	43.0	32.0	140	10.0	9.0
2B	TNG	15.0	21.0	49.0	37.0	160	13.0	12.0
3B	TNG	18.0	25.0	58.0	43.0	190	15.0	14.0

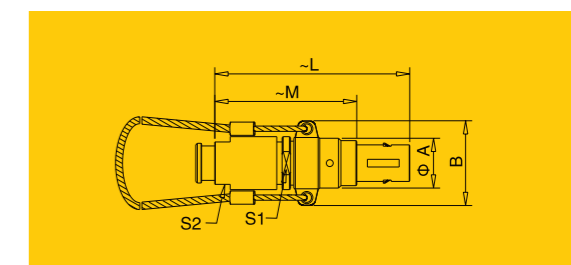

THG Elbow (90°) plug

Key (G) or keys (A...M and R), cable collet

Reference	Dimensions (mm)								
Series	Model	A	D	H	L	M	S1	S2	S3
00B	THG	7.0	5.5	20.0	25.0	17.0	7.0	6.0	5.5
0B	THG	11.0	7.0	31.6	32.0	21.6	10.0	7.0	8.0
1B	THG	13.5	9.5	30.5	38.5	27.2	11.0	9.0	10.0
2B	THG	16.5	10.0	41.5	36.0	32.0	12.0	12.0	13.0
3B	THG	19.0	10.0	50.0	43.0	35.0	15.0	14.0	15.0

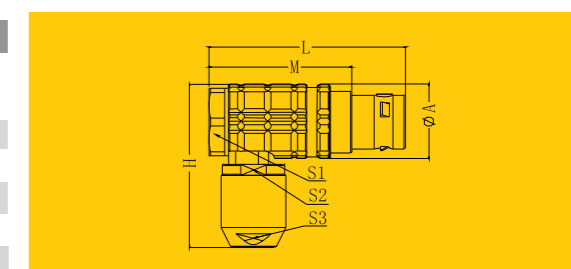

TSG Anglissimo right angle plug



Key (G) or keys (A...M and R), cable collet

Reference		Dimensions (mm)					
Series	Model	A	H	L	M	S1	S2
0B	TSG	10.0	24.6	30.3	20.3	7.5	8.9
3B	TSG	19.0	28.0	50.0	35.0	14.0	16

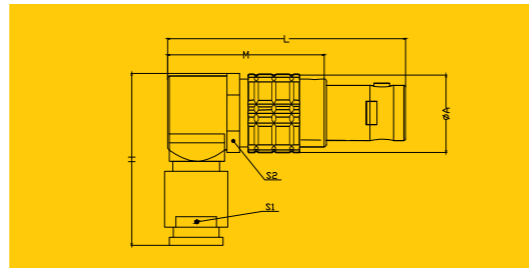

TAG Fixed plug



Non-latching, nut fixing, key (G) or keys (A...M and R)

Reference		Dimensions (mm)								
Series	Model	A	B	e	E	L	M	N1)	S1	
0B	TAG	10.0	12.4	M9x0.6	4.2	20.8	11.2	18.9	8.2	
1B	TAG	14.0	15.8	M12x1.0	5.4	25.2	12.5	21.6	10.5	
2B	TAG	18.0	19.2	M15x1.0	6.0	28.7	13.8	23.9	13.5	
3B	TAG	22.0	25.0	M18x1.0	5.8	32.1	17.0	30.2	16.5	

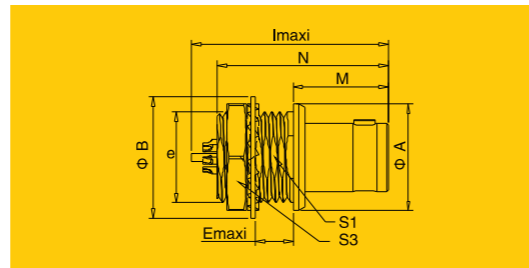

ZGG Fixed socket

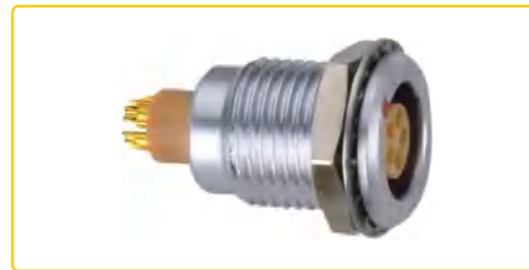

Nut fixing, key (G) or keys (A...M and R)

Reference		Dimensions (mm)									
Series	Model	A	B	e	E	L	M	N1)	S1	S3	
00B	ZGG	8.0	10.2	M7x0.5	6.0	15.5	1.0	13.7	6.3	9.0	
0B	ZGG	10.0	12.4	M9x0.6	7.0	20.7	1.2	19.1	8.2	11.0	
1B	ZGG	14.0	15.8	M12x1.0	7.5	23.0	1.5	21.1	10.5	14.0	
2B	ZGG	18.0	19.2	M15x1.0	8.5	26.7	1.8	24.6	13.5	17.0	
3B	ZGG	22.0	25.0	M18x1.0	11.5	30.7	2.0	28.1	16.5	22.0	
4B	ZGG	28.0	34.0	M25x1.0	12.0	35.7	2.5	34.1	23.5	30.0	

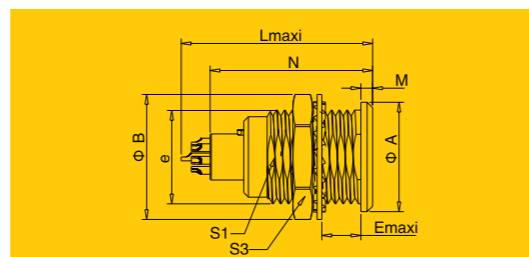

ZCG Fixed socket with two nuts

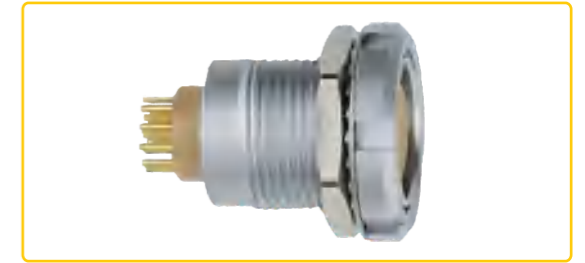

Key (G) or keys (A...F and R) and straight contact for printed circuit(back panel mounting)

Reference		Dimensions (mm)								
Series	Model	A	B	e	E	L	M	N1	S1	S3
0B	ZCG	12.0	12.4	M9x0.6	5.5	20.7	2.5	19.1	8.2	11.0
1B	ZCG	16.0	15.8	M12x1.0	6.0	23.0	3.5	21.1	10.5	14.0
2B	ZCG	20.0	19.2	M15x1.0	6.5	26.7	3.5	24.6	13.5	17.0
3B	ZCG	24.0	25.0	M18x1.0	9.0	30.7	4.5	28.1	16.5	22.0

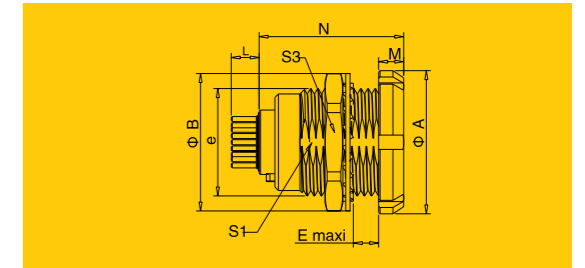

ZCG Fixed socket with two nuts



Key (G) or keys (A...M and R) (back panel mounting)

Reference		Dimensions (mm)								
Series	Model	A	B	e	E	L	M	N1)	S1	S3
0B	ZCG	12.0	12.4	M9x0.6	5.5	20.7	2.5	19.1	8.2	11.0
1B	ZCG	16.0	15.8	M12x1.0	6.0	23.0	3.5	21.1	10.5	14.0
2B	ZCG	20.0	19.2	M15x1.0	6.5	26.7	3.5	24.6	13.5	17.0
3B	ZCG	24.0	25.0	M18x1.0	9.0	30.7	4.5	28.1	16.5	22.0

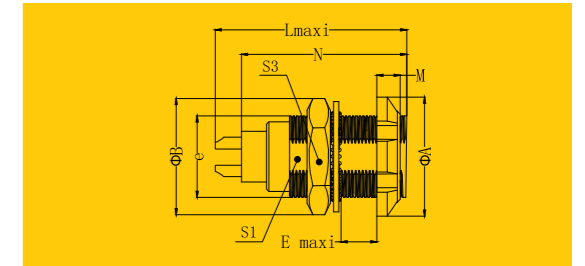

ZEG Fixed socket

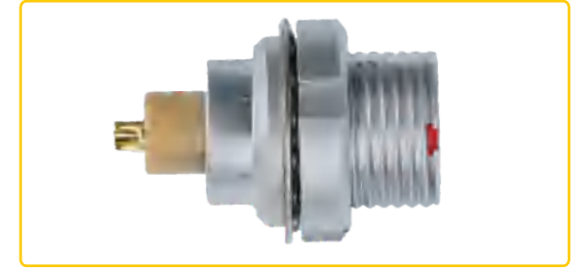

Nut fixing, key (G) or keys (A...M and R) (back panel mounting)

Reference		Dimensions (mm)									
Series	Model	A	B	e	E	L	M	N1)	P	S1	
0B	ZEG	12.0	12.5	M9x0.6	2.4	20.7	2.5	19.1	6.3	8.2	
1B	ZEG	16.0	16.0	M12x1.0	6.5	23.0	3.5	21.1	11.0	10.5	
2B	ZEG	20.0	20.0	M15x1.0	3.0	26.7	3.5	24.6	9.0	13.5	
3B	ZEG	24.0	25.0	M18x1.0	5.0	30.7	4.5	28.1	12.0	16.5	

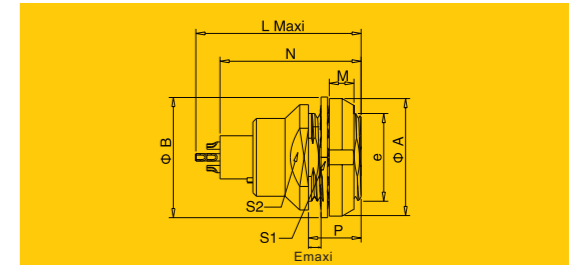

ZCG Fixed socket with two nuts

Key (G) or keys (A...F) with elbow (90°) contact for printed circuit (back panel mounting)

Reference		Dimensions (mm)							
Series	Model	A	B	e	E	M	N	S1	S3
0B	ZCG	12.0	12.4	M9x0.6	5.0	2.5	19.1	8.2	11.0
1B	ZCG	16.0	15.8	M12x1.0	6.0	3.5	21.1	10.5	14.0
2B	ZCG	20.0	19.2	M15x1.0	6.5	3.5	24.6	13.5	17.0
3B	ZCG	24.0	25.0	M18x1.0	9.0	4.5	28.1	16.5	22.0

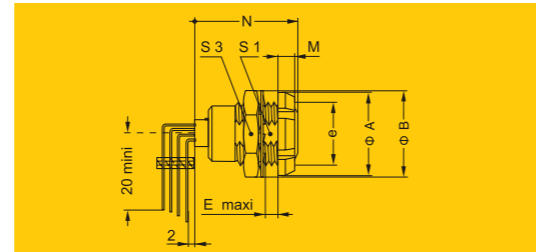

MGG Fixed socket

Nut fixing, key (G) or keys (A...M and R), watertight or vacuumtight

Reference		Dimensions (mm)							
Series	Model	A	B	e	E	L	M	S1	S3
0B	MGG	13.0	12.4	M9x0.6	7.0	20.2	3.0	8.2	11.0
1B	MGG	18.0	15.8	M12x1.0	7.0	26.6	4.5	10.5	14.0
2B	MGG	20.0	19.2	M15x1.0	8.0	31.6	4.0	13.5	17.0

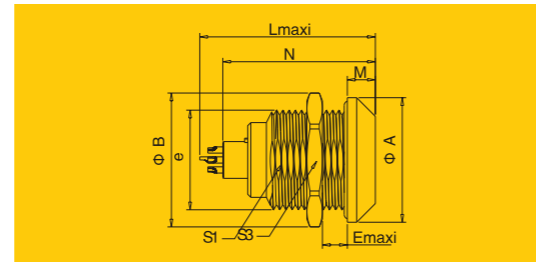

MHG Fixed socket

Nut fixing, key (G) or keys (A...M), watertight or vacuumtight (watertight when mated)

Reference		Dimensions (mm)							
Series	Model	A	B	e	E	L	M	S1	S3
0B	MHG	13.0	12.4	M9x0.6	7.0	23.2	4.8	8.2	11.0
1B	MHG	18.0	15.8	M12x1.0	7.0	30.3	5.2	10.5	14.0
2B	MHG	22.0	19.2	M15x1.0	8.0	35.6	6.0	13.5	17.0

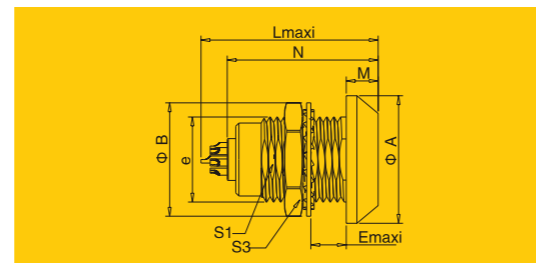

MEG Fixed socket

Nut fixing, key (G) or keys (A...M and R), watertight or vacuumtight

Reference		Dimensions (mm)								
Series	Model	A	B	e	E	L	M	P	S1	S2
0B	MEG	12	13	M9x0.6	5.5	20.2	2.5	9.0	8.2	10
1B	MEG	16	18	M12x1.0	5.5	26.6	3.5	11.0	10.5	14
2B	MEG	20	20	M15x1.0	5.5	31.6	3.5	9.6	13.5	15

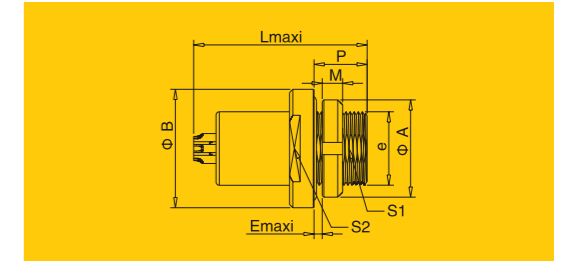

ZEG Fixed socket

Nut fixing, key (G) or keys (A...F) with elbow (90°) contact for printed circuit

Reference		Dimensions (mm)								
Series	Model	A	B	e	E	L	M	N1)	P	S1
0B	ZEG	12	12.5	M9x0.6	2.4	20.7	2.5	19.1	6.3	8.2
1B	ZEG	16	16.0	M12x1.0	6.5	23.0	3.5	21.1	11.0	10.5
2B	ZEG	20	20.0	M15x1.0	3.0	26.7	3.5	24.6	9.0	13.5
3B	ZEG	24	25.0	M18x1.0	5.0	30.7	4.5	28.1	12.0	16.5

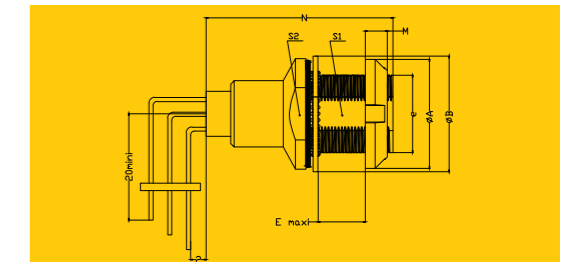

DHG Free socket

Key (G) or keys (A...M and R), cable collet and nut for fitting a bend relief

Reference		Dimensions (mm)			
Series	Model	A	L	S1	S2
00B	DHG	6.8	27.0	5.5	6
0B	DHG	9.5	35.5	8.0	7
1B	DHG	12.5	40.5	10.0	9
2B	DHG	16.5	47.0	13.0	12
3B	DHG	18.0	56.0	16.0	14

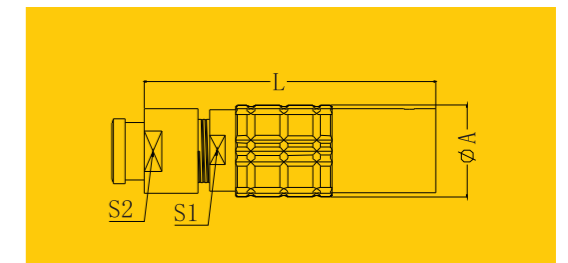

DHG Free socket

Key (G) or keys (A...M and R), cable collet

Reference		Dimensions (mm)				
Series	Model	A	L	S1	S2	
00B	DHG	6.8	27.5	5.5	6	
0B	DHG	9.5	35.5	8.0	7	
1B	DHG	12.5	40.5	10.0	9	
2B	DHG	16.0	47.0	13.0	12	
3B	DHG	18.0	60.0	16.0	14	

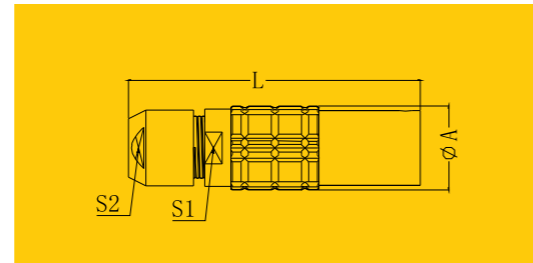

ZZG Straight socket for printed circuit

Key (G) or keys (A...M and R)

Reference		Dimensions (mm)				
Series	Model	A	B	H	K	N
0B	ZZG	9	10	7.62	8	16
1B	ZZG	11	11.8	7.7	9	20

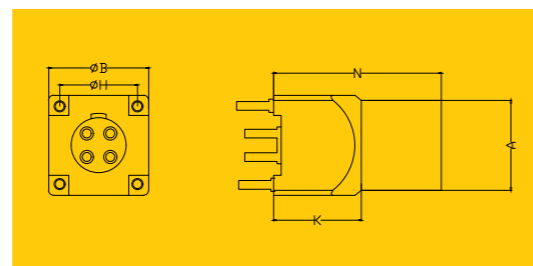
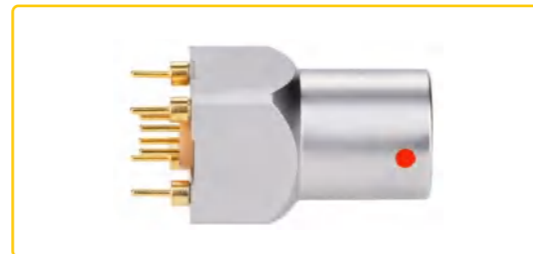

DFG Fixed socket

With two nuts, key (G) or keys (A...M and R), cable collet (back panel mounting)

Reference		Dimensions (mm)									
Series	Model	A	B	e	E	L	M	S1	S2	S3	
0B	DFG	10	12.4	M9x0.6	7.0	35.5	1.2	8.2	7	11	
1B	DFG	14	15.8	M12x1.0	7.5	40.5	1.5	10.5	9	14	
2B	DFG	18	19.2	M15x1.0	8.5	47	1.8	13.5	12	17	
3B	DFG	22	25.0	M18x1.0	11.5	56	2.0	16.5	14	22	

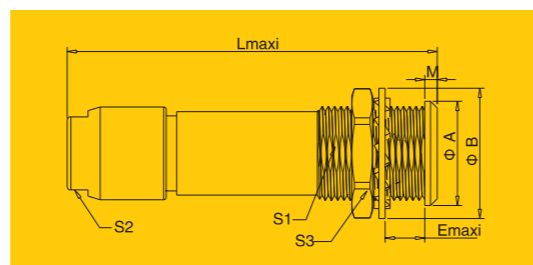

ZHG Fixed socket

Nut fixing, key (G) or keys (A...M and R), and protruding shell

Reference		Dimensions (mm)								
Series	Model	A	B	e	E	M	L	N1	S1	S3
0B	ZHG	10	12.4	M9x0.6	2	12.5	19.5	19.1	8.2	11
1B	ZHG	14	15.8	M12x1.0	4	12.0	21.7	21.1	10.5	14
2B	ZHG	18	19.2	M15x1.0	5.1	12.5	22.7	24.6	13.5	17
3B	ZHG	22	25.0	M18x1.0	7.1	13.5	30.7	30.3	16.5	22

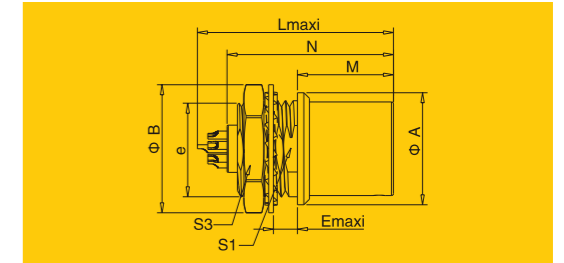

ZPG Elbow (90°) socket for printed circuit

Key (G) or keys (A...F) (solder, screw or harpoon fixing)

Series	Dimensions (mm)							
	A	D	H	I	K	L	N	R
00B	6.8	11.9	5.4	9.6	9.1	19.25	9.1	5
0B	9.0	14.6	6.7	12.7	13.3	25.0	11.7	7.62
1B	11.0	16.6	7.5	14.0	13.3	27.0	12.6	7.62
2B	15.0	17.5	12.75	18	17	32	17	12

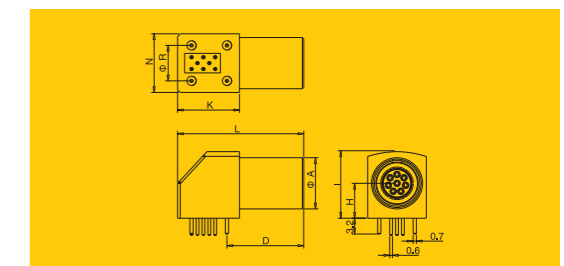

ZXG Elbow (90°) socket for printed circuit with two nuts

Key (G) or keys (A...F) (solder, screw or harpoon fixing)(back panel mounting)

Series	Dimensions (mm)												
	A	B	D	e	E	H	I	K	L	M	N	R	S3
00B	10	10.3	11.5	M7x0.5	2.5	5.4	7	9.1	19.32	5.9	15.08	9	
0B	12	12.4	14.6	M9x0.6	6.0	6.7	12.7	13.3	25.02	5.11	17.77	11	
1B	14	15.0	16.6	M11x0.5	7.5	7.5	14.0	13.3	27.03	5.12	17.77	13	
2B	20	20.0	17.5	M15x1.0	8.0	12.75	18.0	17.0	32.03	5.17	12.0	17	

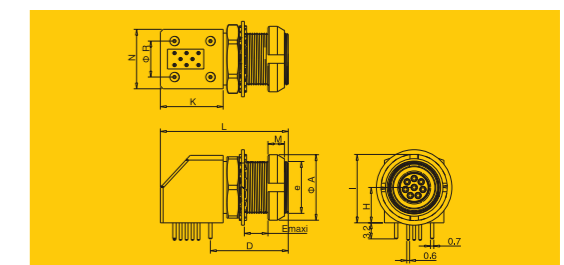

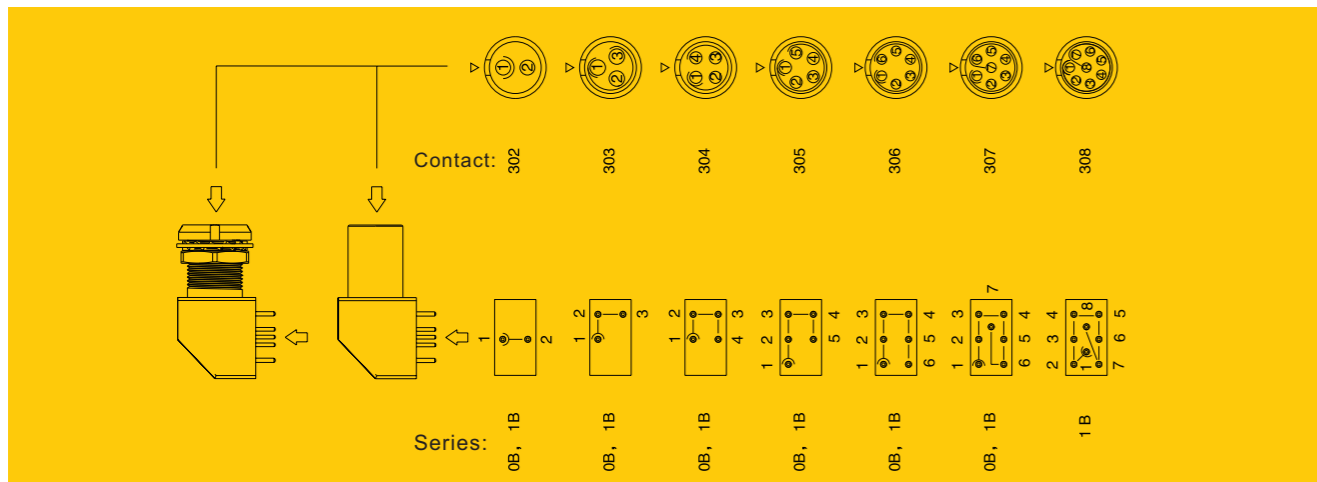

Alignment Key and Polarized Keying System

B series connector model part numbers are composed of three letters. The LAST LETTER indicates the key position and the contact type (male or female).

Front view of a socket	Ref.	Nb of keys	Angles	Series			Ref.	Nb of keys	Angles	Series				Contact type		Note
				00	0B	1B				2B	3B	4B	5B	Plug	Socket	
	G	1		0°	0°	0°	G	1		0°	0°	0°	0°	male	female	●
	A	2	α	30°	30°	30°	A	2	α	30°	30°	30°	30°	male	female	●
	B	2		60°	60°	60°	B	2		45°	45°	45°	45°	male	female	●
	C	2		-	90°	90°	C	2		60°	60°	60°	60°	male	female	●
	D	2	β	-	135°	135°	D	2	γ	95°	95°	95°	95°	male	female	○
	E	2		-	145°	145°	E	2		120°	120°	120°	120°	male	female	○
	F	2		-	155°	155°	F	2		145°	145°	145°	145°	male	female	○
	J	2	γ	45°	45°	45°	J	2	α	37.5°	37.5°	37.5°	37.5°	female	male	●
	K	2		-	70°	70°	K	2		52.5°	52.5°	52.5°	52.5°	female	male	○
	L	2		-	80°	80°	L	2		70°	70°	70°	70°	female	male	○
	M	2	δ	-	110°	-	M	2	β	-	-	-	-	female	male	○
	Y	3		-	-	-	Y	3		112.5°	126°	112.5°	-	male	female	● ¹⁾
										γ	100°	102°	147.5°	-		

Spanners for hexagonal nuts



An illustrative

B series plug and socket separation instruction

When the plug and socket are plugged in, pinch the plug shell with the pattern with your thumb and forefinger (as indicated by the red arrow in picture 1), and then pull the plug along the end of the plug (as indicated by the green arrow in picture 1) to separate it (as shown in picture 2).
 Note: It is not necessary to twist the plug to separate from the socket.

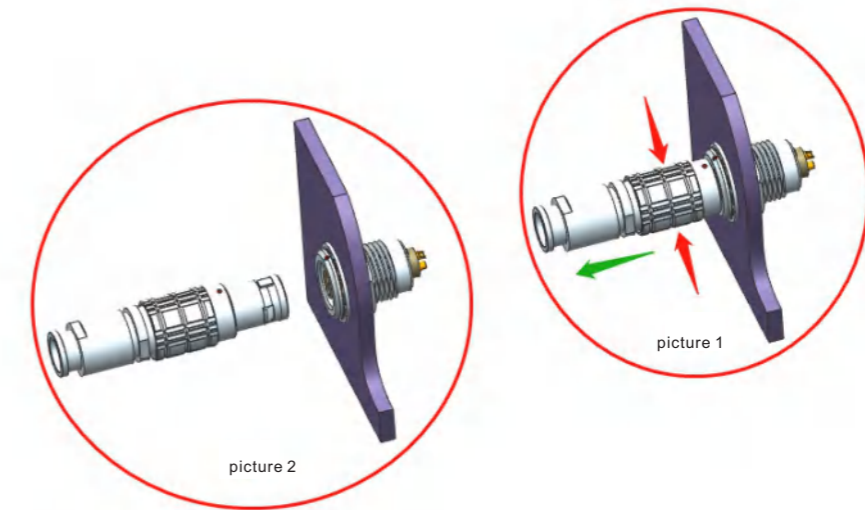

B series plug decomposition diagram

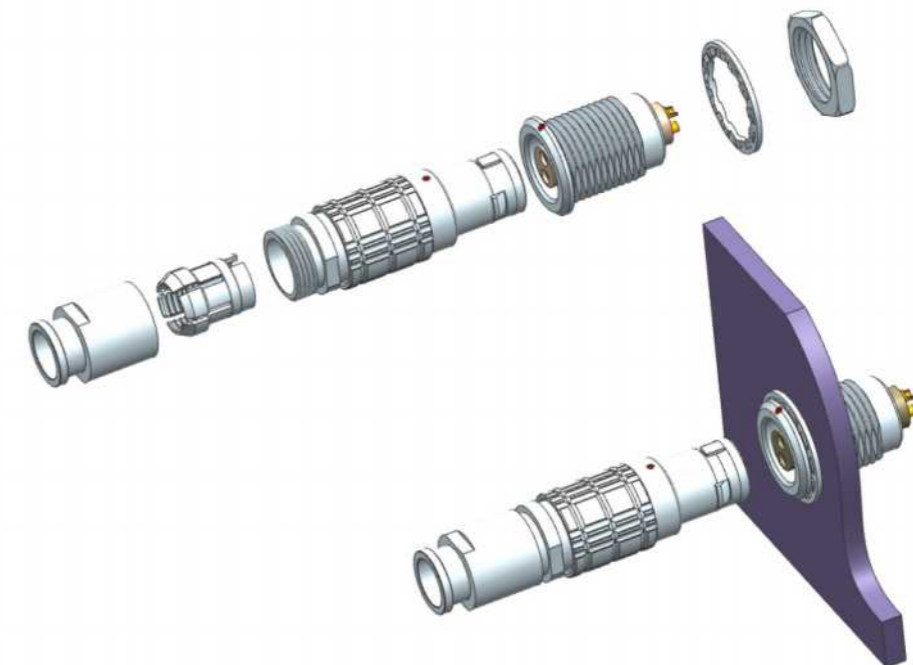



K series

K series connectors have been specifically designed for outdoor applications.

All models of this series are watertight when mated to give a protection index of IP68 (IP66 otherwise) when correctly assembled to an appropriate cable. K series connectors have the same insulators as the B series and have the following main features.

- security of the Push-Pull latching system.
- High packing density for space savings.
- 360° screening for full EMC shielding.
- Keying system («G» key standard).
- Multipole types 2 to 32 contacts.
- Watertight connection (IP 68/IP 66).
- Solder or print (straight or elbow) contacts.
- Multiple key options to avoid cross mating for connector alignment of similar connectors.
- Rugged housing for extreme working conditions.

Part Numbering System of K series

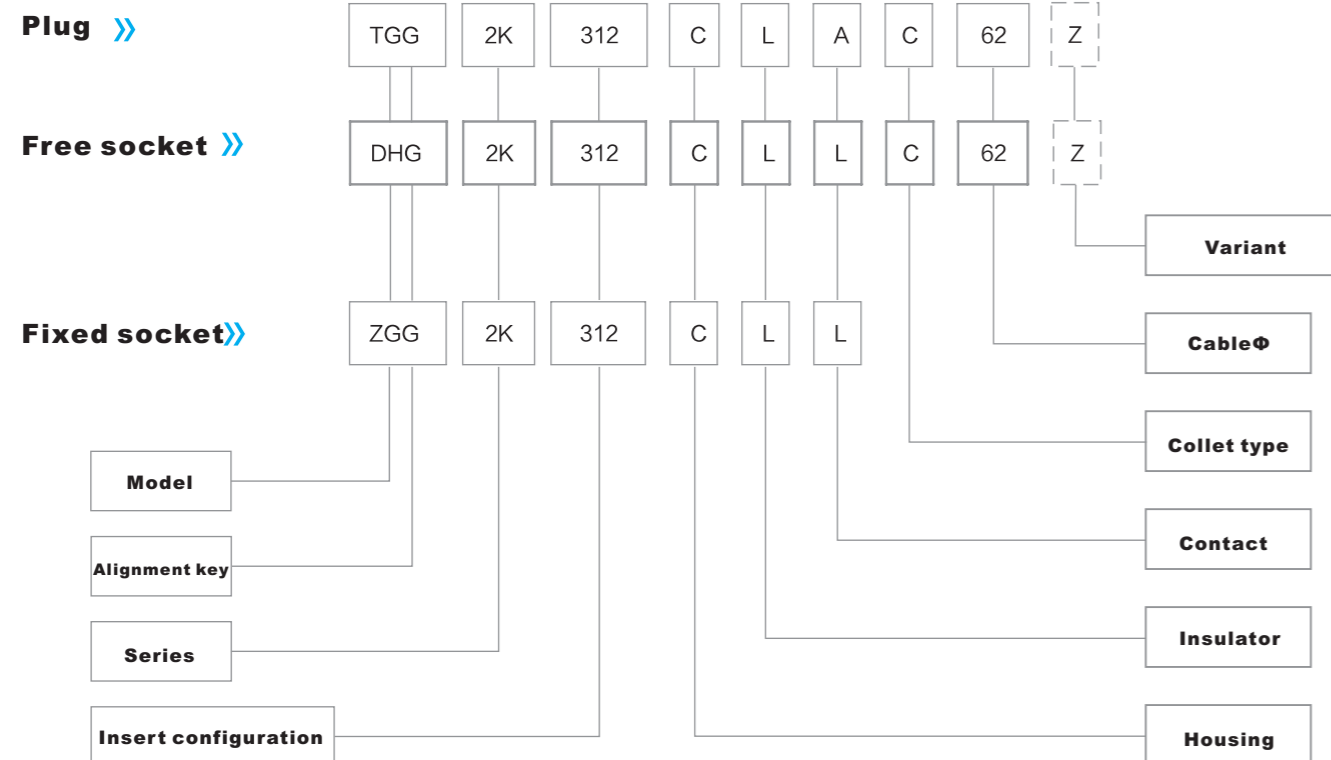

Technical Characteristics of K series:

Mechanical and Climatical:

- Endurance: > 5000 cycles
- Humidity: up to 95% at 60°C
- Temperature range: - 55°C, + 250°C
- Resistance to vibrations: 10-2000 Hz, 15g
- Shock resistance: 100g, 6ms
- Salt spray corrosion test: > 48h
- Protection index (mated): IP 66~68

Housings (B and K series)

Ref.	Outer shell and collet nut		Latch sleeve + earthing crown		Other metallic components	
	Material	Surf. treatment	Material	Surf. treatment	Material	Surf. treatment
C	Brass	chrome	brass/bronze	nickel	brass	nickel
N	Brass	nickel	brass/bronze	nickel	brass	nickel
K	Brass	black chrome	brass/bronze	nickel	brass	nickel
S	Stainless steel	—	brass/bronze	nickel	brass	nickel
T	Stainless steel	—	stainless steel	nickel	brass	nickel
U	Stainless steel	—	stainless steel	nickel	stainless steel	—
L	Aluminium alloy	anodized	brass/bronze	nickel	brass	nickel
X	Aluminium alloy	nickel anthracite	brass/bronze	nickel	brass	nickel

Note: In the K series, the latch sleeve is nickel-plated.

Examples of Product Numbers

▲ Straight plug with cable collet:

TGG.2K.312.CLAC62 = straight plug with key (G) and cable collet, 2K series, multipole type with 12 contacts, outer shell in chrome-plated brass, PPS insulator, male solder contacts, C type collet for 6.2 mm diameter cable.

▲ Free socket:

DHG.2K.312.CLLC62 = free socket with key (G) and cable collet, 2K series, multipole type with 12 contacts, outer shell in chrome-plated brass, PPS insulator, female solder contacts, C type collet for 6.2 mm diameter cable.

▲ Fixed socket:

ZGG.2K.312.CLL = fixed socket, nut fixing, with key (G), 2K series, multipole type with 12 contacts, outer shell in chrome-plated brass, PPS extended insulator, female solder contacts.

Part Section Showing Internal Components

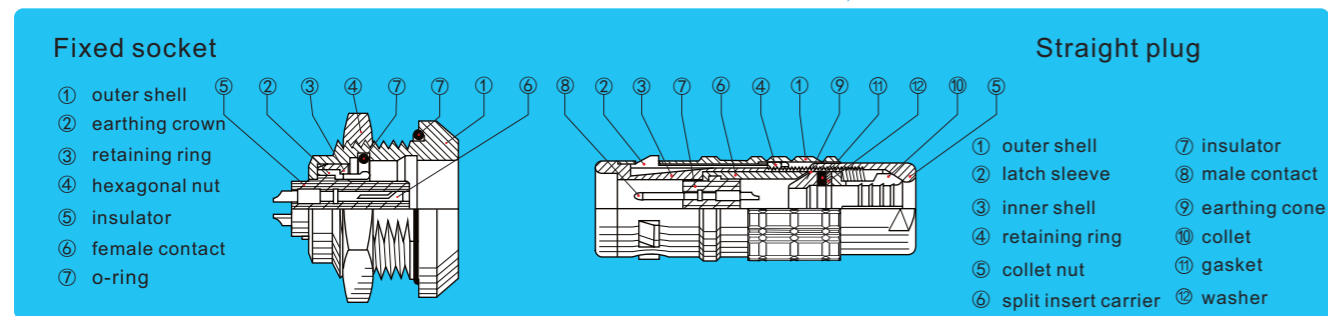

TGG Straight plug

Key (G) or keys (A to F, L and R), cable collet

Reference	Dimensions (mm)				
Series	Model	A	L	M	S1
0K	TGG	11	34	23	8
1K	TGG	13	42	28	9
2K	TGG	16	52	36	12
3K	TGG	19	61	41	14

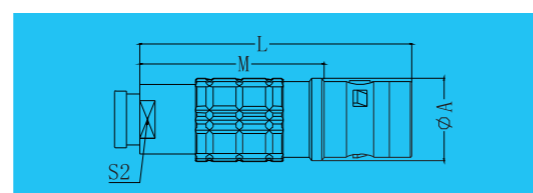
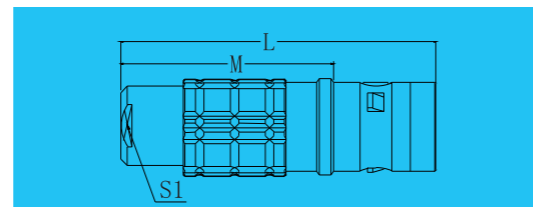
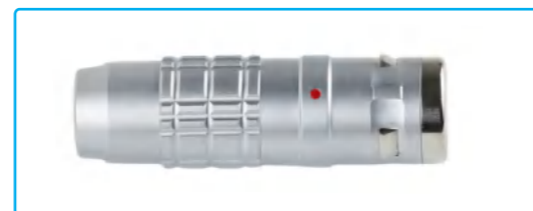

TGG Straight plug

Key (G) or keys (A to F, L and R), cable collet and nut for fitting a bend relief

Reference	Dimensions (mm)				
Series	Model	A	L	M	S2
0K	TGG	11	34	23	7
1K	TGG	13	42	28	9
2K	TGG	16	52	36	12
3K	TGG	19	60	40	15

ZGG Fixed socket

Nut fixing, key (G) or keys (A to F, L and R)

Reference	Dimensions (mm)									
Series	Model	A	B	e	E	L	M	N1)	S1	S3
0K	ZGG	18	19.2	M14x1.0	6	21.7	4.0	20.1	12.5	17
1K	ZGG	20	21.5	M16x1.0	9	27.0	4.5	25.1	14.5	19
2K	ZGG	25	27.0	M20x1.0	9	30.7	5.0	28.6	18.5	24
3K	ZGG	31	34	M24x1.0	11	36.2	6.0	33.6	22.5	30

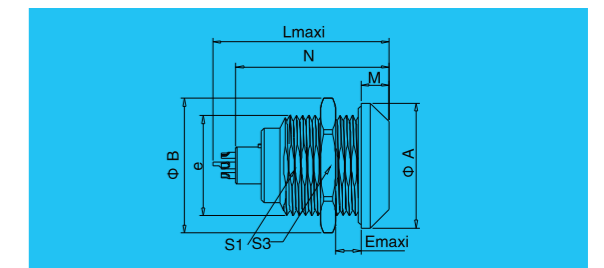

ZEG Fixed socket

Nut fixing, key (G) or keys (A to F, L and R) (back panel mounting)

Reference	Dimensions (mm)									
Series	Model	A	B	e	E	L	M	N1)	D	S1
0K	ZEG	18	18	M14x1.0	3.4	21.7	3.5	20.1	7	12.5
1K	ZEG	20	20	M16x1.0	6.2	27.0	3.5	25.1	10	14.5
2K	ZEG	25	25	M20x1.0	6.2	30.7	3.5	28.6	10	18.5

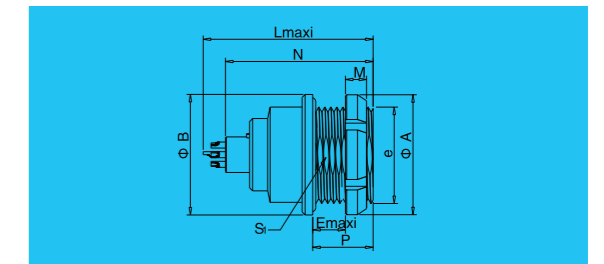

ZEG Fixed socket

Nut fixing, key (G) or keys (A to F, L and R) with straight print contacts for printed circuit (back panel mounting)

Reference	Dimensions (mm)									
Series	Model	A	B	e	E	L	M	N1)	S1	S3
0K	ZEG	18	18	M14x1.0	3.4	21.7	3.5	20.1	7	12.5
1K	ZEG	20	20	M16x1.0	6.2	27.0	3.5	25.1	10	14.5
2K	ZEG	25	25	M20x1.0	5.0	30.7	3.5	28.6	10	18.5

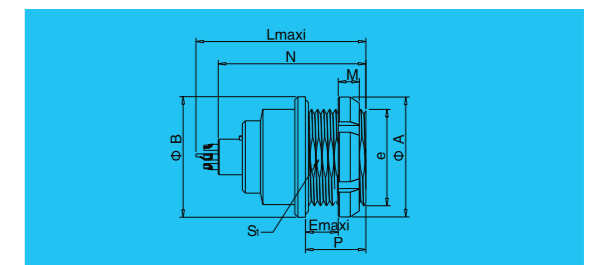

DHG Free socket

Key (G) or keys (A to F, L and R), cable collet and nut for fitting a bend relief

Reference		Dimensions (mm)		
Series	Model	A	L	S2
0K	DHG	13	34	7
1K	DHG	15	45	9
2K	DHG	19	54	12
3K	DHG	23	65	15

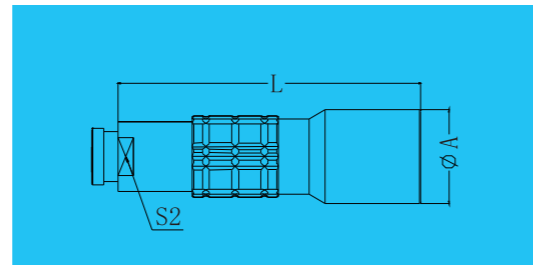

DHG Free socket

Key (G) or keys (A to F, L and R), cable collet

Reference		Dimensions (mm)		
Series	Model	A	L	S2
0K	DHG	13	34.0	8
1K	DHG	15	42.0	9
2K	DHG	19	52.0	12
3K	DHG	23	66.0	15

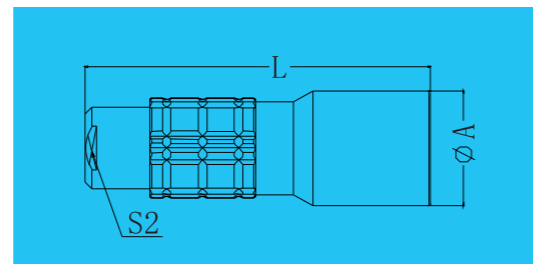

THG Elbow (90°) plug

Key (G) or keys (A to F, L and R), cable collet or bend relief

Reference		Dimensions (mm)				
Series	Model	A	L	M	H	S1
0K	THG	11.5	36	25.0	27	10
1K	THG	14.0	43	29.0	33	12
2K	THG	17.5	51	35.0	40	15
3K	THG	21.0	60	40.0	47	18

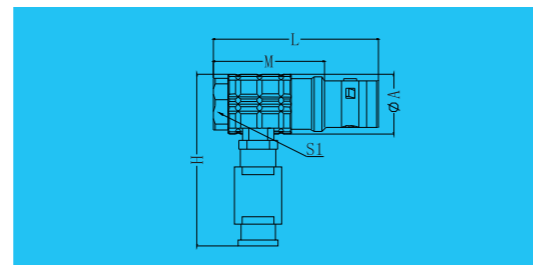

ZEG Fixed socket

Nut fixing, key (G) or keys (A to F and L) with elbow (90°) contacts for printed circuit(back panel mounting)

Reference		Dimensions (mm)							
Series	Model	A	B	e	E	M	N	P	S1
0K	ZEG	18	18	M14x1.0	3.4	3.5	19.3	7	12.5
1K	ZEG	20	20	M16x1.0	6.2	3.5	24.3	10	14.5
2K	ZEG	25	25	M20x1.0	5.0	3.5	26.6	10	18.5

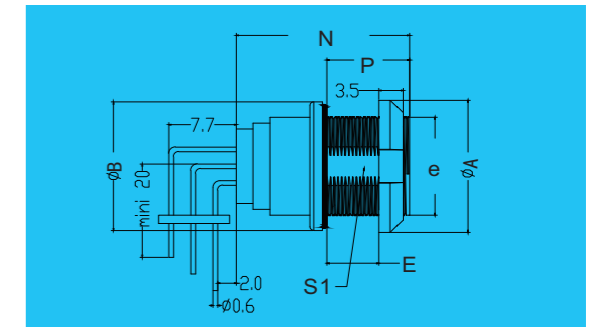
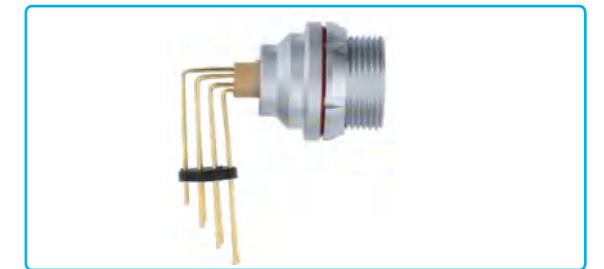

MGG Fixed socket

Nut fixing, key (G) or keys (A to F and L), watertight or vacuumtight

Reference		Dimensions (mm)							
Series	Model	A	B	e	E	L	M	S1	S3
0K	MGG	18	19.2	M14x1.0	5.5	21.7	4.0	12.5	17
1K	MGG	20	21.5	M16x1.0	9.0	30.0	4.5	14.5	19
2K	MGG	25	27.0	M20x1.0	13.0	33.7	5.0	18.5	24

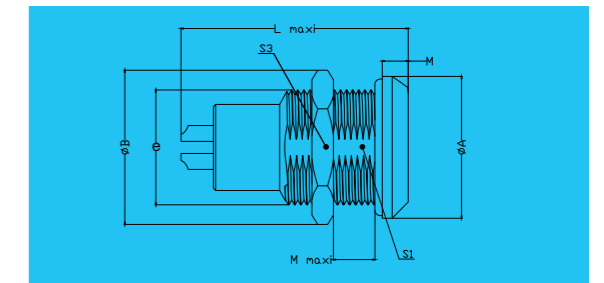

Alignment Key and Polarized Keying System

K series connector model part numbers are composed of three letters. The LAST LETTER indicates the key position and the contact type (male or female).

Ref.	Nb of keys	Angles	Series				Contact type	
			0K	1K	2K	3K	Plug	Socket
G	1	α	0°	0°	0°	0°	male	female
A	2		30°	30°	30°	30°	male	female
B	2		45°	45°	45°	45°	male	female
C	2		60°	60°	60°	60°	male	female
D	2	γ	95°	95°	95°	95°	male	female
E	2		120°	120°	120°	120°	male	female
F	2	β	145°	145°	145°	145°	male	female
L	2		75°	75°	75°	75°	female	male

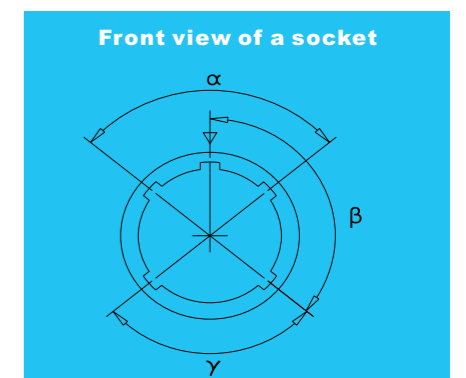

An illustrative

K series plug and socket separation instruction

When the plug and socket are plugged in, pinch the plug shell with the pattern with your thumb and forefinger (as indicated by the red arrow in picture 1), and then pull the plug along the end of the plug (as indicated by the green arrow in picture 1) to separate it (as shown in picture 2).
 Note: It is not necessary to twist the plug to separate from the socket.

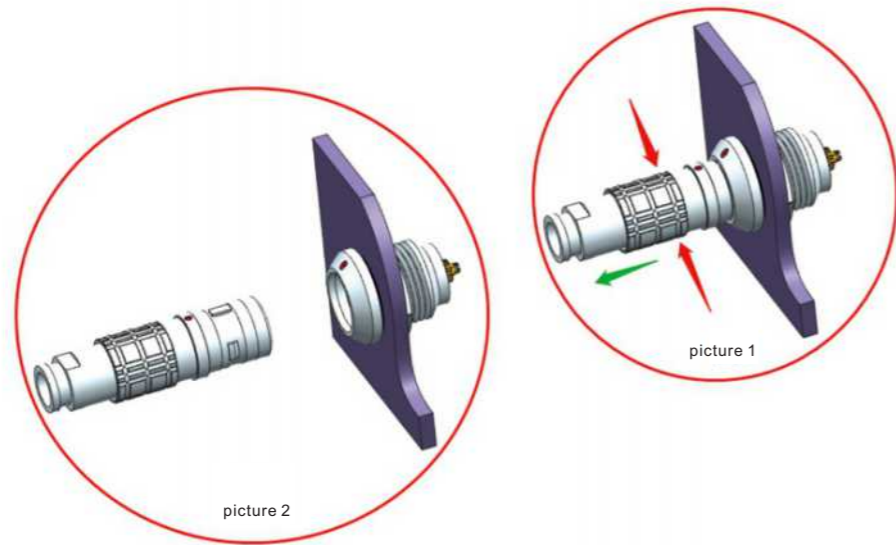

K series plug decomposition diagram

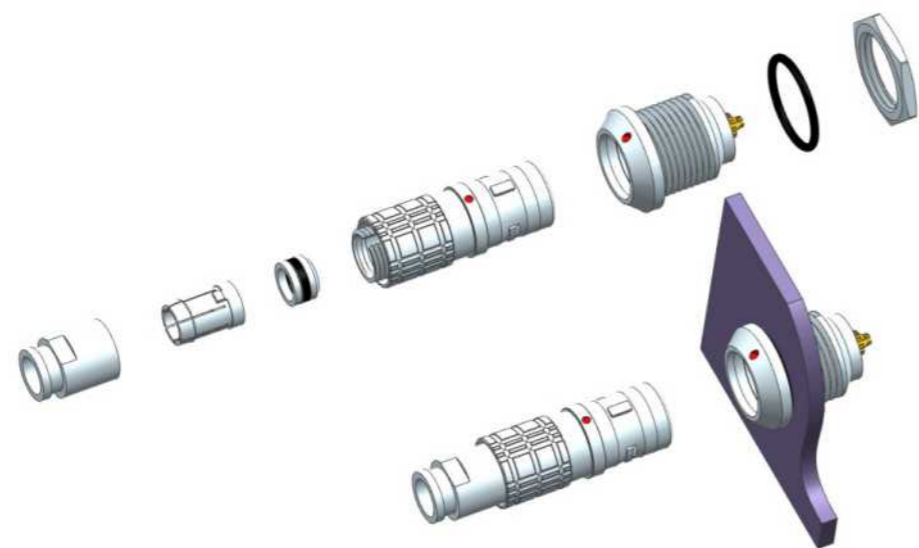

Part Numbering System of S series:

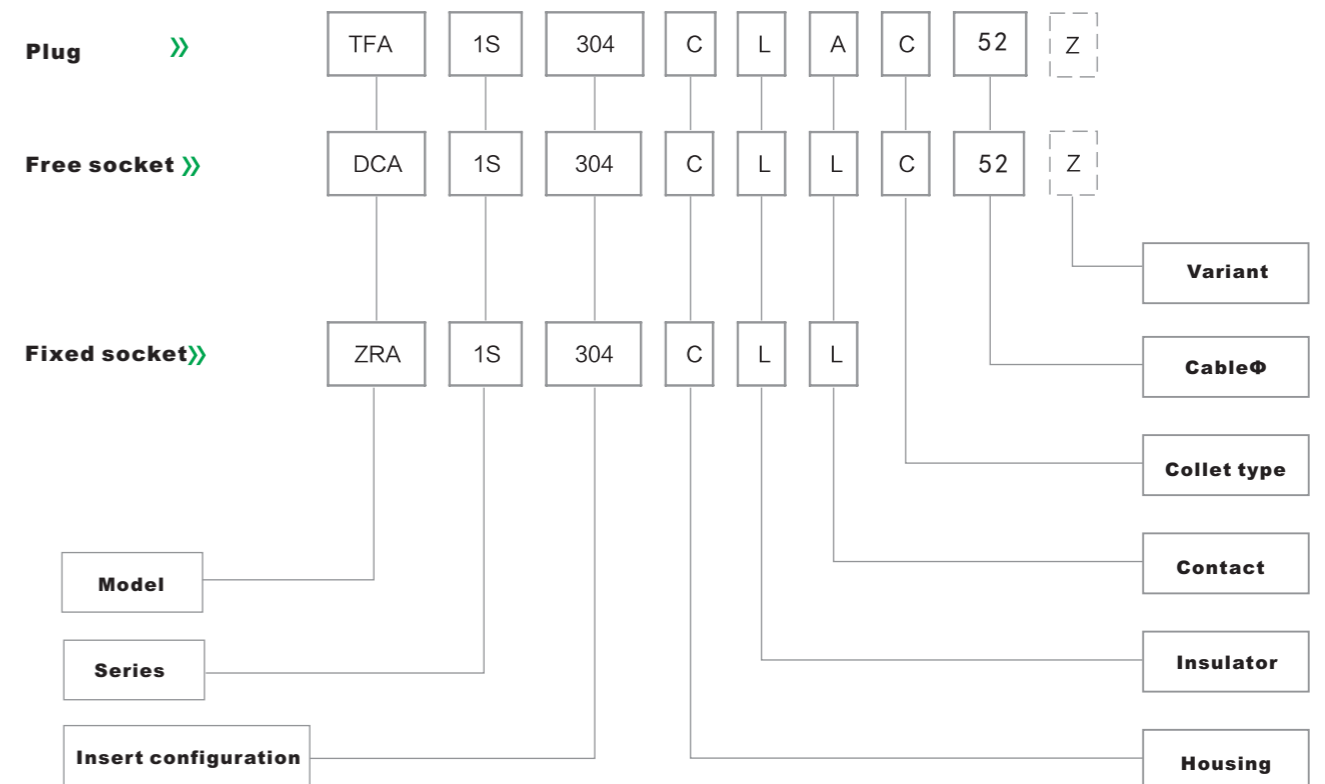

S series

S series connectors have main features as follows:

- security of the Push-Pull self-latching system.
- Multipole types 2 to 10 contacts.
- Molder or print contacts (straight or elbow).
- Polarisation by stepped insert (half-moon).
- Multipole types with up to 10 contacts fitted with male and female contacts.
- 360° screening for full EMC shielding.

Examples of Product Numbers

▲ Straight plug with cable collet:

TFA.1S.304.CLAC52 = straight plug with cable collet, 1S series, multipole type with 4 contacts, outer shell in chrome-plated brass, PPS insulator, 2 male and 2 female solder contacts, C type collet for a 5.2 mm diameter cable.

▲ Free socket:

DCA.1S.304.CLLC52Z = free socket, with cable collet, 1S series, multipole type with 4 contacts, outer shell in chrome-plated brass, PPS insulator, 2 female and 2 male solder contacts, C type collet for a 5.2 mm diameter cable and nut for fitting a bend relief.

▲ Fixed socket:

ZRA.1S.304.CLL = fixed socket, nut fixing, 1S series, multipole type with 4 contacts, outer shell in chrome-plated brass, PPS insulator, 2 female and 2 male solder contacts.

Part Section Showing Internal Components

Fixed socket

- ① outer shell
- ② earthing crown
- ③ retaining ring
- ④ hexagonal nut
- ⑤ locking washer
- ⑥ insulator
- ⑦ male contact
- ⑧ female contact

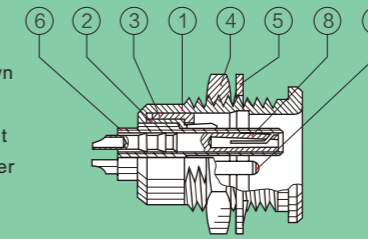

Straight plug

- ① outer shell
- ② latch sleeve
- ③ collet nut
- ④ centre-piece
- ⑤ insulator
- ⑥ male contact
- ⑦ female contact
- ⑧ collet

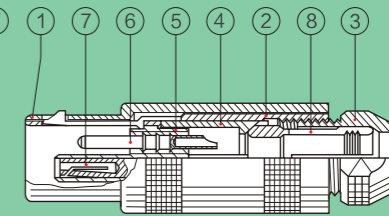

TFA Straight plug



Cable collet

Reference		Dimensions (mm)			
Series	Model	A	L	M	S2
00S	TFA	6.4	26.0	18.0	4.5
0S	TFA	8.8	34.5	24.5	6.5
1S	TFA	11.8	42.5	31.5	8.5
2S	TFA	14.8	52.5	40.0	11.0

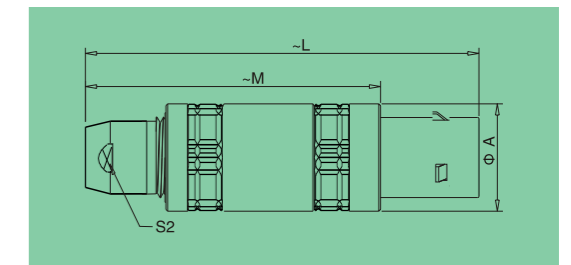

TFA Straight plug

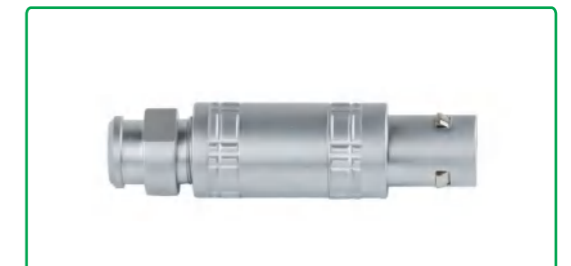

Cable collet and nut for fitting a bend relief

Reference		Dimensions (mm)			
Series	Model	A	L	M	S2
00S	TFA	6.4	26.0	18.0	6
0S	TFA	8.8	34.5	24.5	7
1S	TFA	11.8	42.5	31.5	9
2S	TFA	14.8	52.0	40.0	12

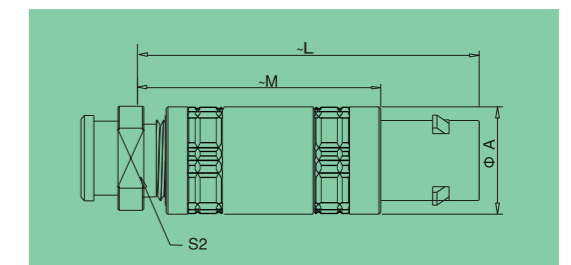

TLA Elbow (90°) plug



Reference		Dimensions (mm)					
Series	Model	A	H	L	M	S1	S2
00	TLA	7.5	16.5	19.5	11.5	4.5	6
0S	TLA	9.5	23.0	30.0	20.0	7.0	8
1S	TLA	12.0	29.0	36.0	25.0	9.0	10
2S	TLA	14.8	35.0	41.5	29.5	12.0	13

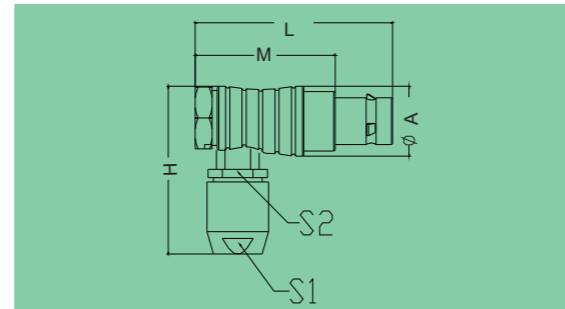

ZRA Fixed socket



Nut fixing

Reference		Dimensions (mm)								
Series	Model	A	B	e	E	L	M	S1	S3	
00	ZRA	8	10.2	M7x0.5	5.5	14.5	1.0	6.3	9	
0S	ZRA	10	12.3	M9x0.6	7.0	21.3	1.2	8.2	11	
1S	ZRA	14	16.0	M12x1.0	7.5	23.2	1.5	10.5	14	
2S	ZRA	18	19.2	M15x1.0	8.0	24.8	2.0	13.5	17	

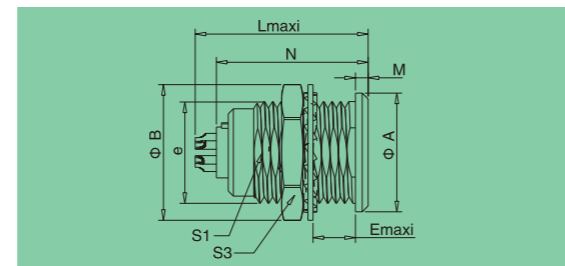

DCA Free socket



Cable collet and nut for fitting a bend relief

Reference		Dimensions (mm)		
Series	Model	A	L	S2
0S	DCA	8.9	33.5	7
1S	DCA	11.9	40.5	9
2S	DCA	14.8	50.0	12

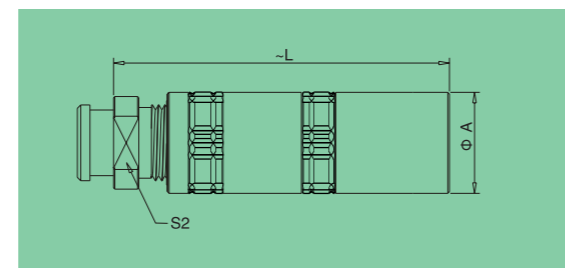

ZCP Fixed socket



With two nuts (back panel mounting)

Reference		Dimensions (mm)									
Series	Model	A	B	e	E	L	M	N	SI	S3	
0S	ZCP	12	12.5	M9x0.6	5.5	21.3	2.5	19.0	8.2	11	
1S	ZCP	16	16.0	M12x1.0	6.0	23.2	3.2	2.01	10.5	14	
2S	ZCP	20	20	M15x1.0	6.5	24.8	3.5	24.5	13.5	17	

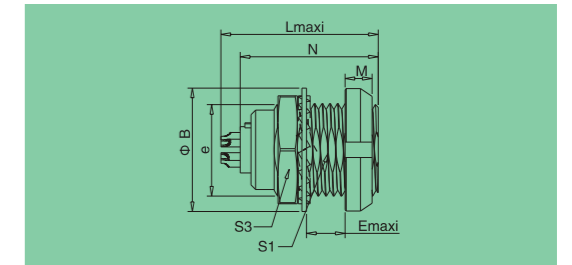

ZRA Fixed socket

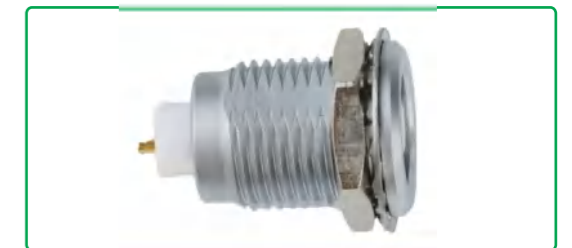

Nut fixing, without earthing tag

Reference		Dimensions (mm)								
Series	Model	A	B	e	E	L	M	S1	S3	
00	ZRA	8	10.2	M7x0.5	5.5	14.5	1.0	6.3	9	
0S	ZRA	10	12.3	M9x0.6	7.0	21.3	1.2	8.2	11	
1S	ZRA	14	16.0	M12x1.0	7.5	23.2	1.5	10.5	14	
2S	ZRA	18	19.2	M15x1.0	8.0	24.8	2.0	13.5	17	

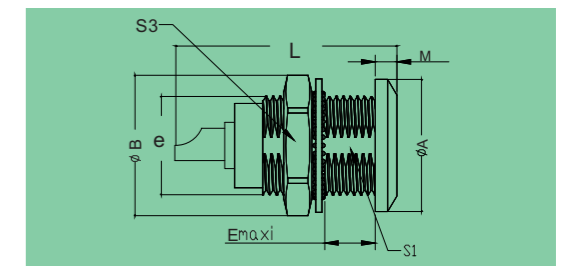

ZRA Fixed socket

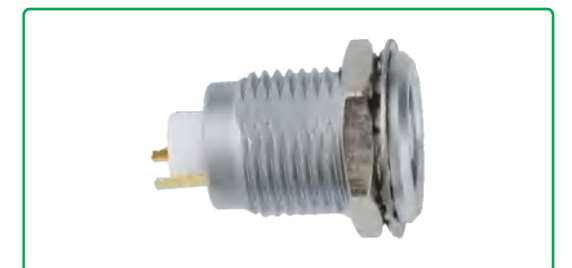

Nut fixing, with earthing tag or with two earthing tags

Reference		Dimensions (mm)								
Series	Model	A	B	e	E	L	M	S1	S3	
00	ZRA	8	10.2	M7x0.5	5.5	14.5	1.0	6.3	9	
0S	ZRA	10	12.3	M9x0.6	7.0	21.3	1.2	8.2	11	
1S	ZRA	14	16.0	M12x1.0	7.5	23.2	1.5	10.5	14	
2S	ZRA	18	19.2	M15x1.0	8.0	24.8	2.0	13.5	17	

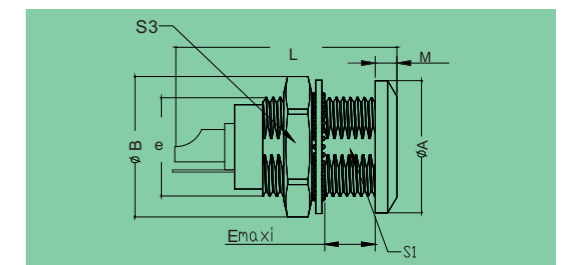

An illustrative

S series plug and socket separation instruction

When the plug and socket are plugged in, pinch the plug shell with the pattern with your thumb and forefinger (as indicated by the red arrow in picture 1), and then pull the plug along the end of the plug (as indicated by the green arrow in picture 1) to separate it (as shown in picture 2).
 Note: It is not necessary to twist the plug to separate from the socket.

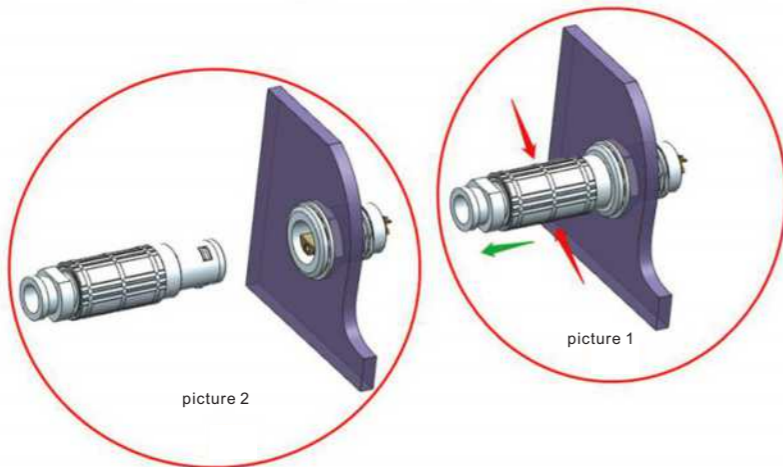

S series plug decomposition diagram

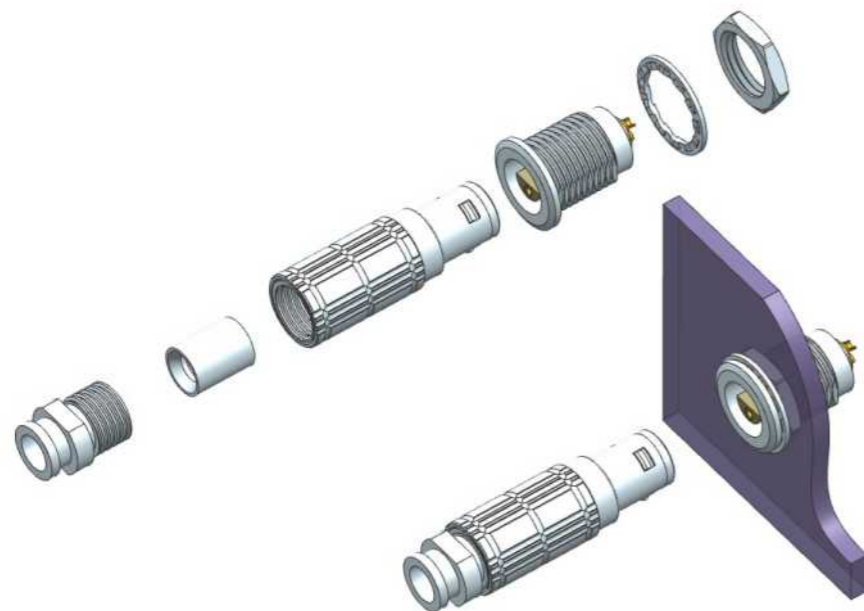

Part Numbering System of F series:

Plug >>

TGG 0F 306 C L A D 52 Z

Free socket >>

DHG 0F 306 C L L D 52 Z

Fixed socket >>

ZGG 0F 306 C L L

Model

Alignment key

Series

Insert configuration

Variant

CableΦ

Collet type

Contact

Insulator

Housing

F series

F series connectors have main features as follows:

The F series connectors have been specially developed to meet the most demanding requirements in terms of dimensions, weight and watertightness. Our manufacturing programme includes now 8 series. This series provides customers with many features and benefits including:

- Push-pull self-latching system for safe connection.
- Protection index (mated): IP 66~68.
- Solder or print contacts (straight or elbow).
- Multipole types 2 to 26 contacts.
- Semilunar ring positioning to avoid cross mating for connector alignment of similar connectors.
- Rugged housing for extreme working conditions.
- 360° screening for full EMC shielding.

Part Section Showing Internal Components

Fixed socket

- 1 female contact
- 2 slotted nut
- 3 o-ring
- 4 retaining ring
- 5 insulator
- 6 outer shell
- 7 sealant

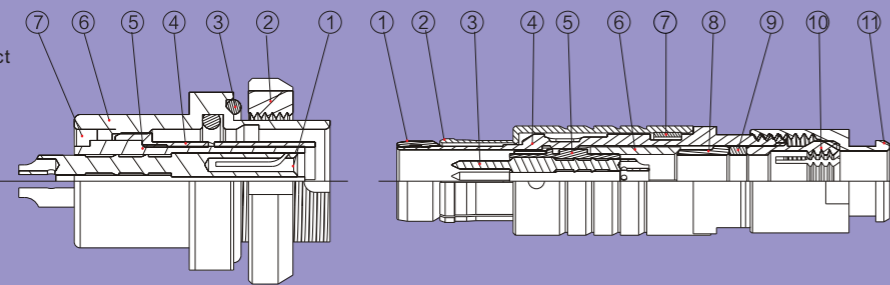

Straight plug

- 1 bushing
- 2 outer shell
- 3 collet nut
- 4 inner bushing
- 5 insulator
- 6 earthing cone
- 7 snap ring
- 8 retaining ring
- 9 o-ring
- 10 collet
- 11 collet nut

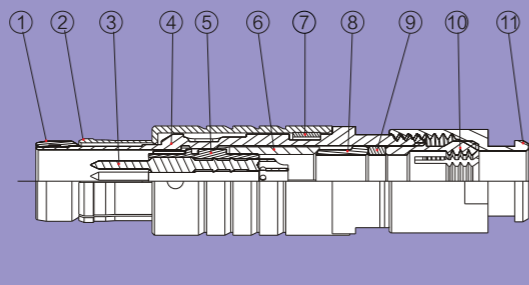

TGG Straight plug



The collet holds the cable in place and the internal parts prevent the cable from turning.
Built-in metal semicircle to prevent accidental insertion.

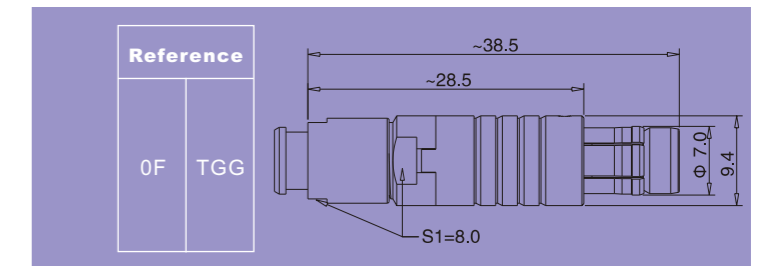

ZGG Fixed socket



Back panel mounting, built-in metal semicircle to prevent accidental insertion. watertight or vacuumtight.

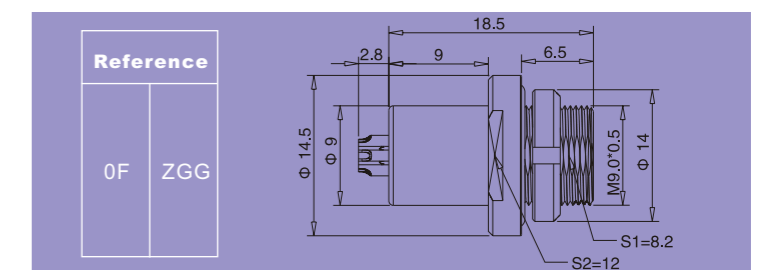

TLG Short straight plug



Built-in metal semicircle to prevent accidental insertion.

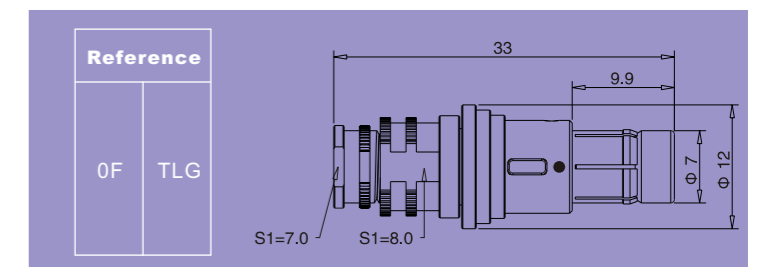

ZLG Short fixed socket



Back panel mounting, built-in metal semicircle to prevent accidental insertion. watertight or vacuumtight.

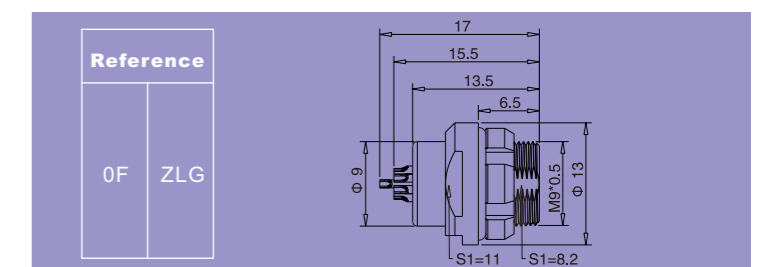

ZLG Short fixed socket



Back panel mounting, built-in metal semicircle to prevent accidental insertion. watertight or vacuumtight.

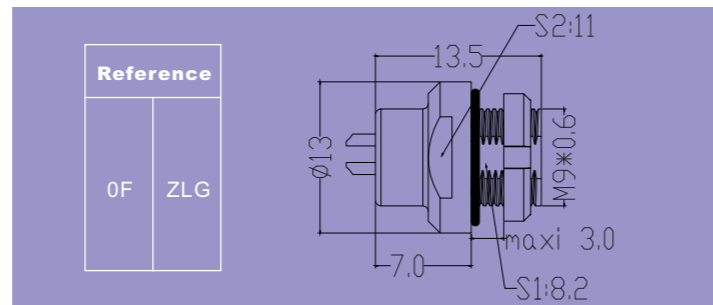

TGG Straight plug



The collet holds the cable in place and the internal parts prevent the cable from turning. Built-in metal semicircle to prevent accidental insertion.

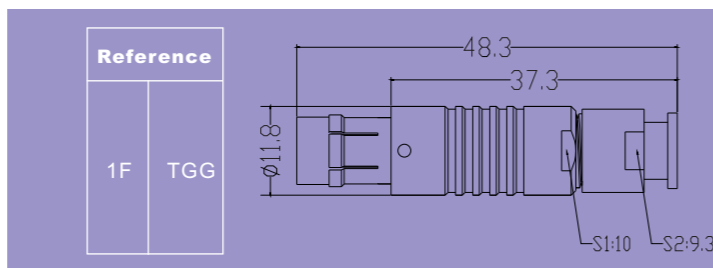

TLG Short straight plug



Built-in metal semicircle to prevent accidental insertion.

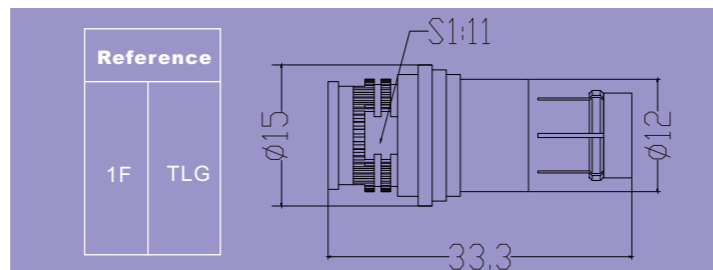

ZGG Fixed socket



Back panel mounting, built-in metal semicircle to prevent accidental insertion. watertight or vacuumtight.

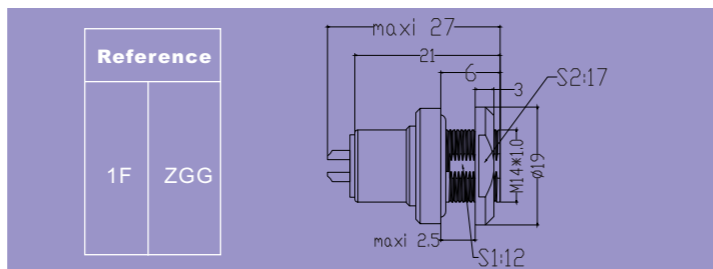

ZGG Fixed socket for printed circuit



ZEG Fixed socket with elbow (90°) contact for printed circuit



Back panel mounting, watertight or vacuumtight, built-in metal semicircle to prevent accidental insertion.

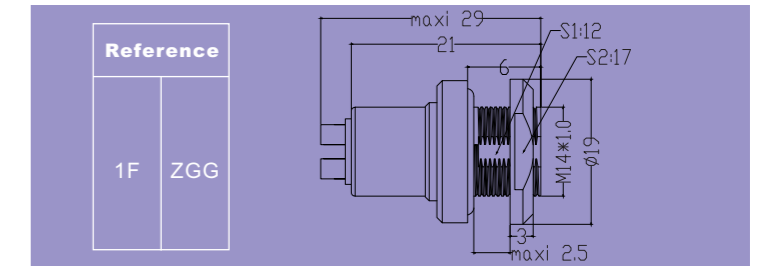

Back panel mounting, built-in metal semicircle to prevent accidental insertion.

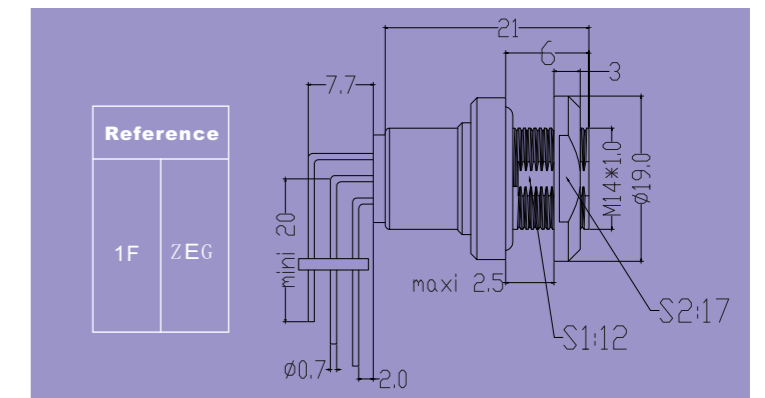

DHG Free socket

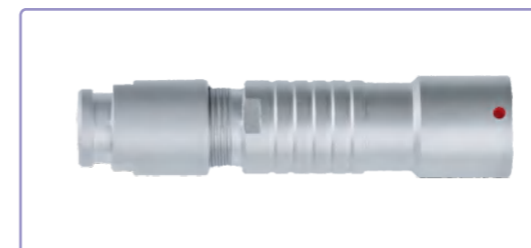

Cable collet and nut for fitting a bend relief. Built-in metal semicircle to prevent accidental insertion.

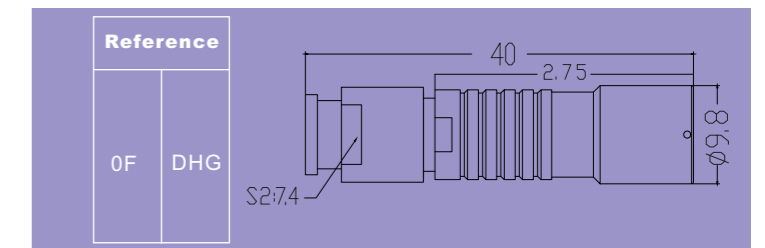

DHG Free socket

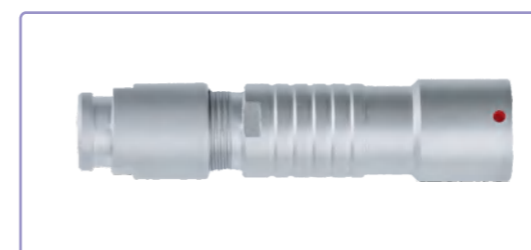

Cable collet and nut for fitting a bend relief. Built-in metal semicircle to prevent accidental insertion.

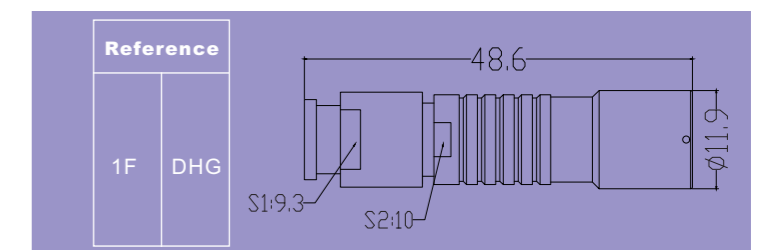

An illustrative

F series plug and socket separation instruction

When the plug and socket are plugged in, pinch the plug shell with the pattern with your thumb and forefinger (as indicated by the red arrow in picture 1), and then pull the plug along the end of the plug (as indicated by the green arrow in picture 1) to separate it (as shown in picture 2).

Note: It is not necessary to twist the plug to separate from the socket.

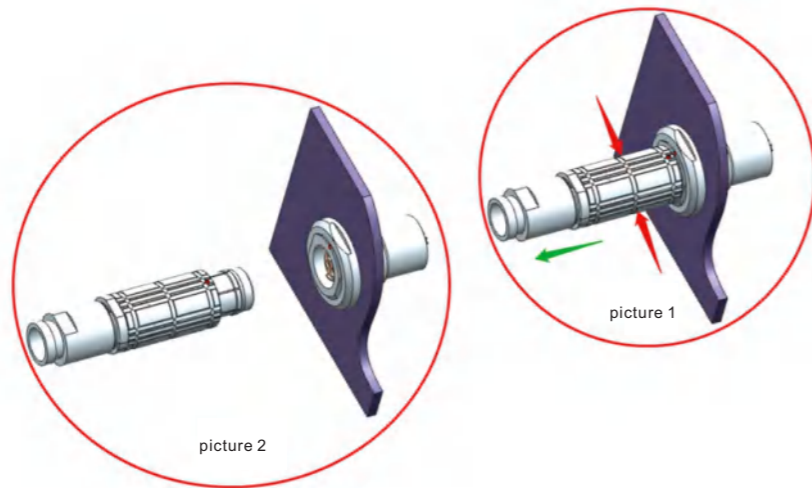

F series plug decomposition diagram

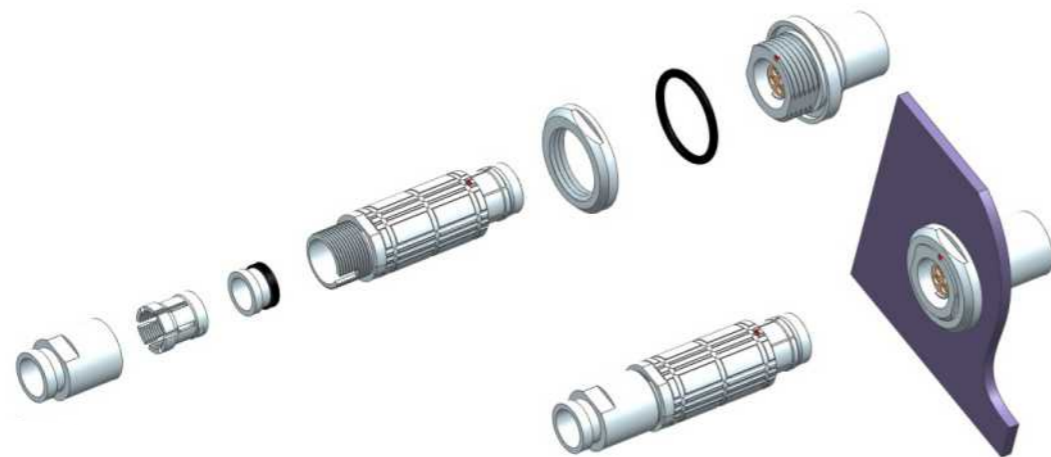

Part Numbering System of P series

Plug >>

PAG 1P 306 G L A D 62 Z

Free socket >>

PRG 1P 306 G L L D 62 Z

Fixed socket >>

PKG 1P 306 C L L

Model

Alignment key

Series

Insert configuration

Variant

CableΦ

Collet type

Contact

Insulator

Housing

P series

P series connectors have main features as follows:

- Security of the Push-Pull self-latching system
- Multipole types 2 to 26 contacts
- Solder or print contacts (straight or elbow)
- A keying system combined with color coding can be incorporated on all connector types to assist in the prevention of mismatching.
- Color coding of the plug collet nut and receptacle flange will give an instant visual indication as to whether connectors are compatible or not.
- Protection index (mated): IP 50

Part Section Showing Internal Components

Fixed socket

- ① female contact
- ② Insulator
- ③ Outershell
- ④ Hexagonal nut
- ⑤ Front nut

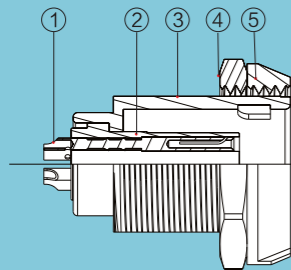

Straight plug

- ① Outer shell
- ② Latch sleeve
- ③ Insulator
- ④ Male contact
- ⑤ Collet
- ⑥ Collet nut

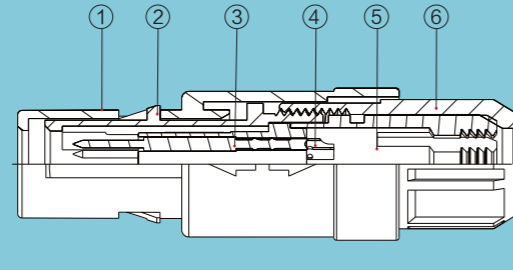

1P PAG Straight plug



With cable collet

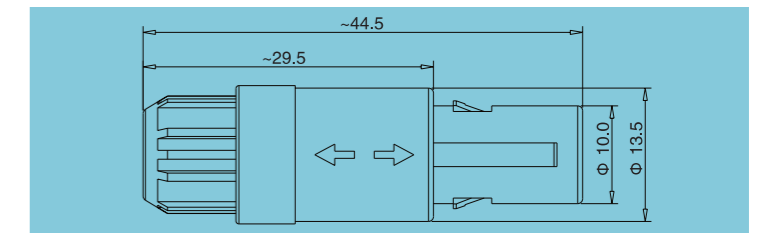

1P PAG Straight plug



With cable collet and nut for fitting a bend relief

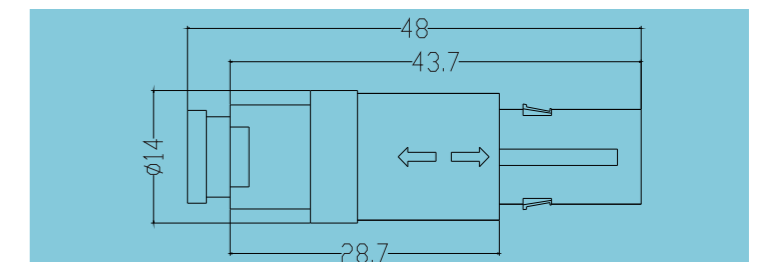

1P PKG Fixed socket



Receptacle with two nuts (back panel mounting)

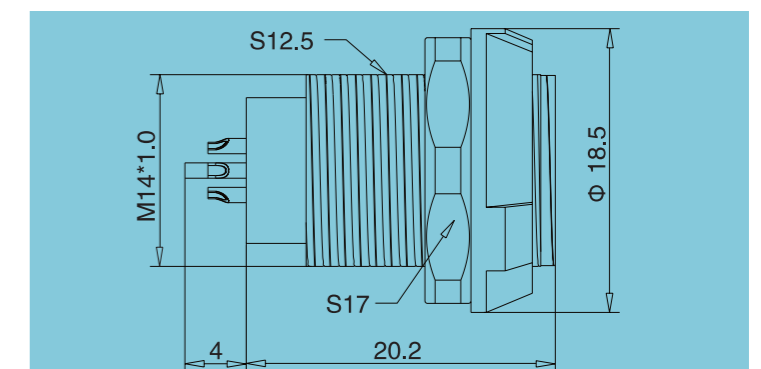

1P PRG Free socket

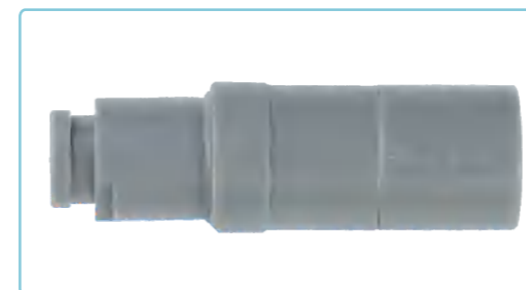

Receptacle with cable collet and nut for fitting a bend relief

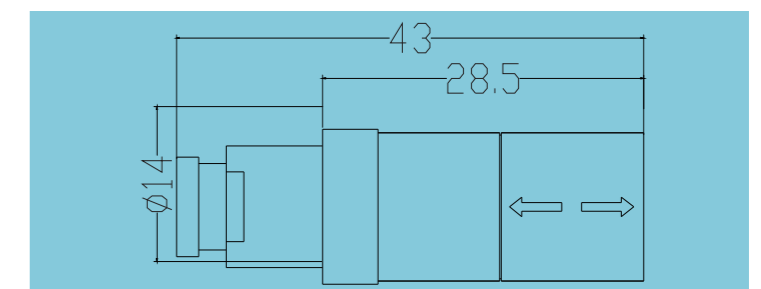

1P PRG Free socket

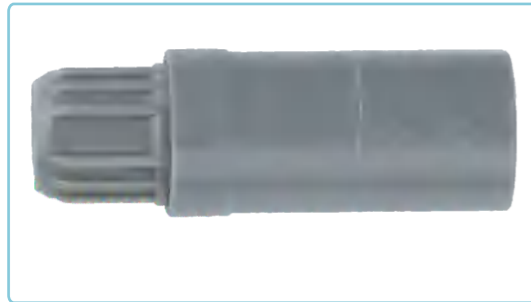

Receptacle with cable collet

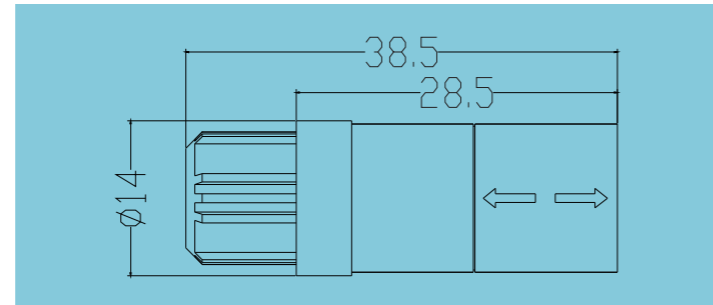

1P PKG Fixed socket(waterproof)



Nut fixing (front panel mounting), built-in seal ring

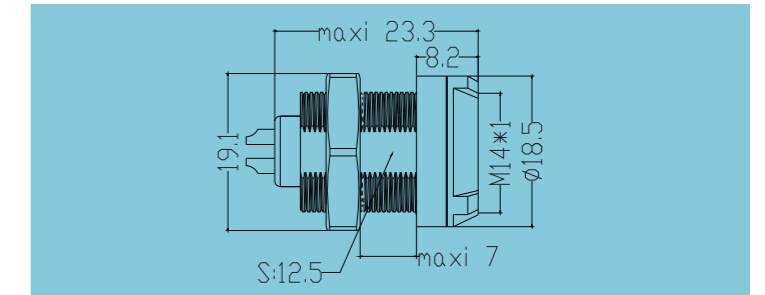

1P PLG Fixed socket



Nut fixing (front panel mounting)

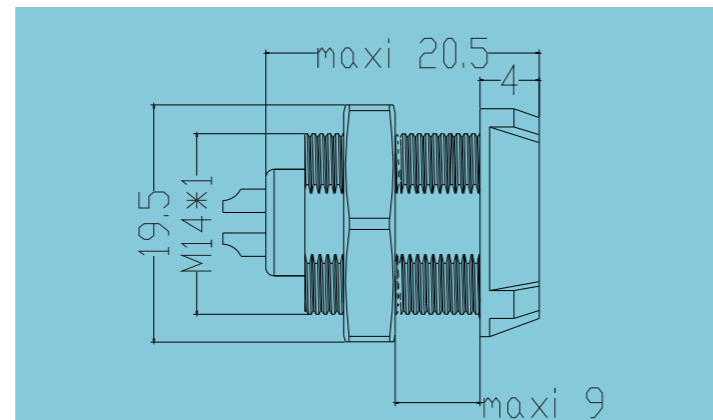

1P PKG Fixed socket



Fixed receptacle with two nuts, with printed contacts circuit (back panel mounting)

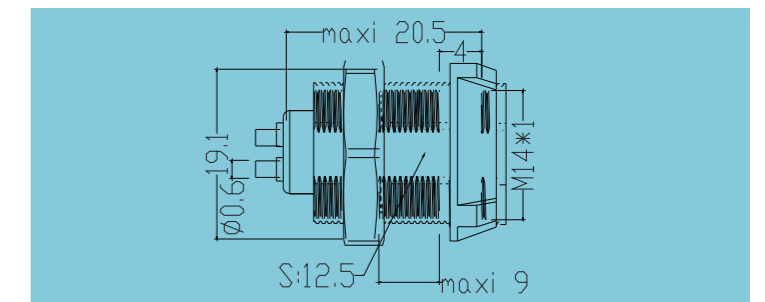

1P PKG Fixed socket

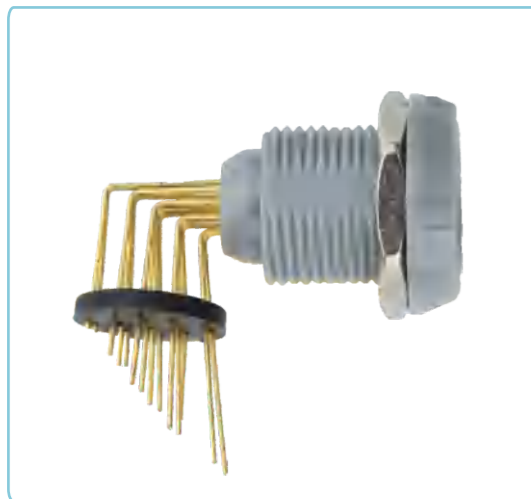

Fixed receptacle with two nuts, with 90° contacts for printed circuit (back panel mounting)

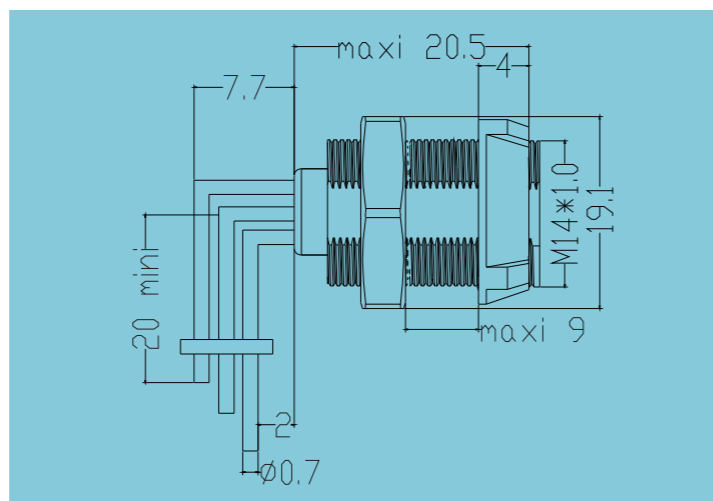

1P PKG Fixed socket

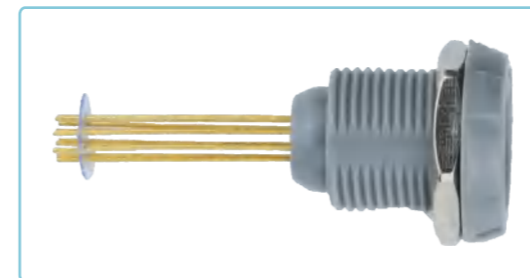

Fixed receptacle with two nuts, with long printed contacts circuit (back panel mounting)

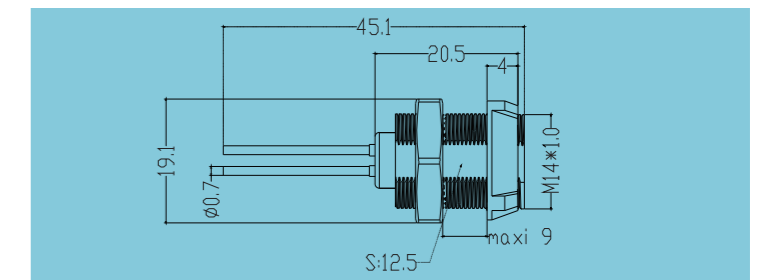

1P PAG Straight plug with one contact

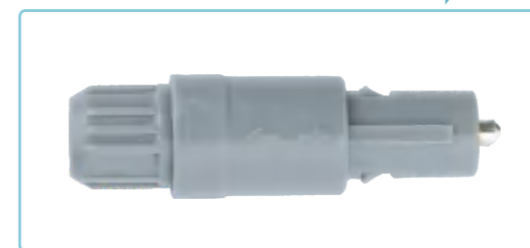

With cable collet and nut for fitting a bend relief

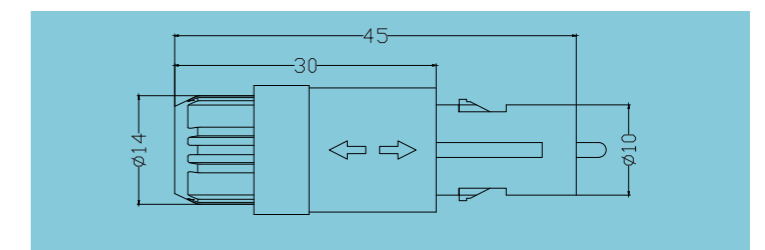

1P PKG Fixed socket with ont contact



Receptacle with two nuts (back panel mounting)

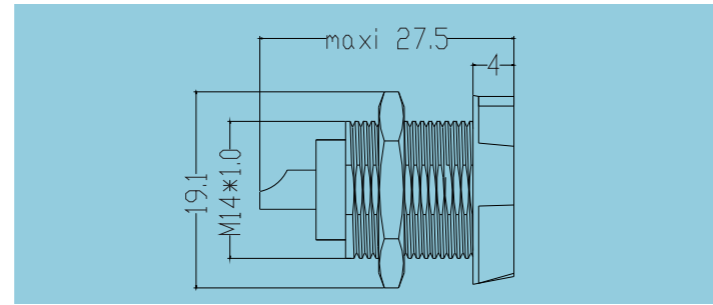

SQL-02 Gas fixed socket

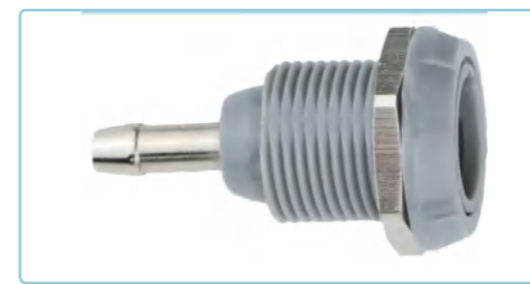

Gas fixed socket with two nuts (back panel mounting)

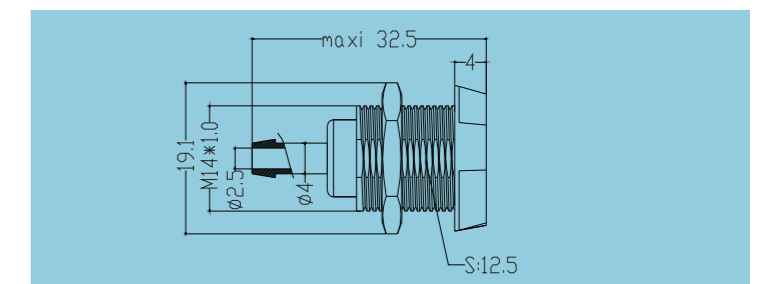

1P MPQG Short straight plug



Short plug

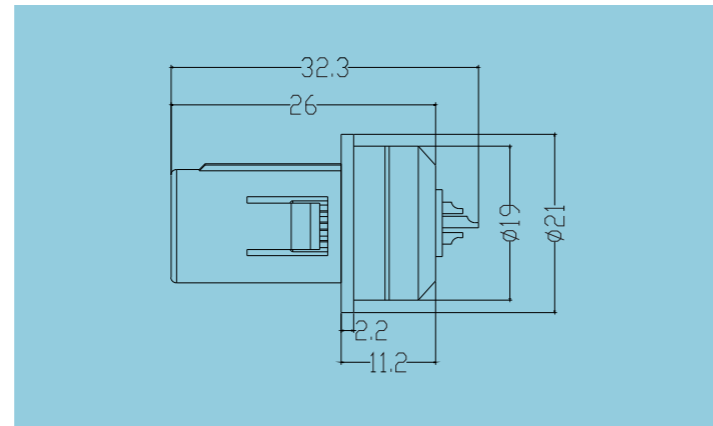

2P CAB Straight plug



With cable collet and nut for fitting a bend relief

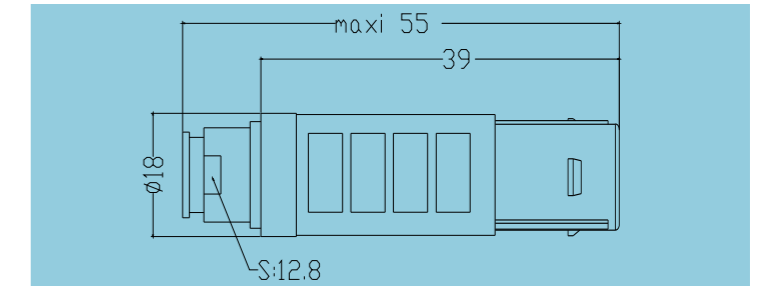

1P PPQG Straight plug



Disposable plug

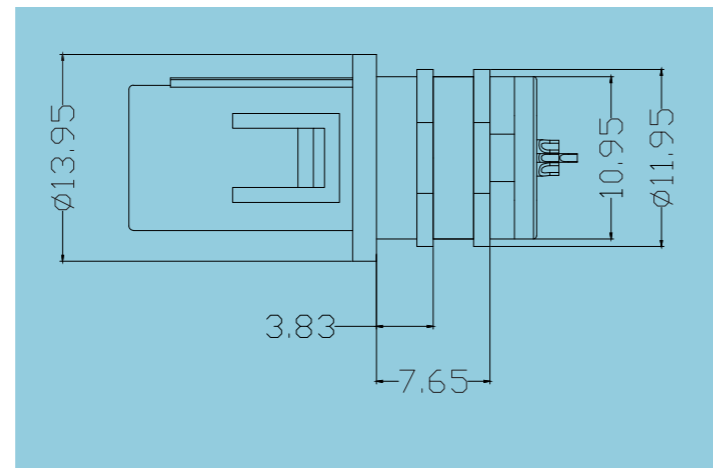

2P CAB Straight plug

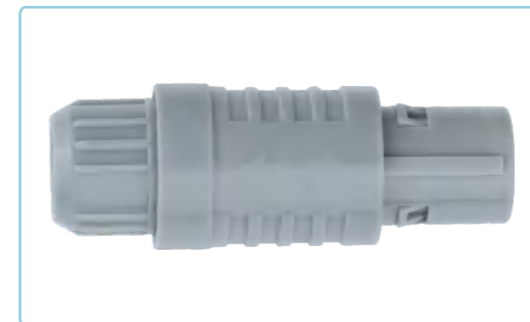

With cable collet

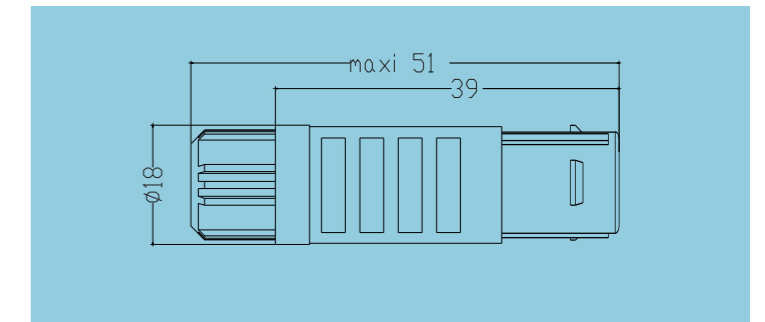

2P CNB Fixed socket



Receptacle, nut fixing,(back panel mounting)

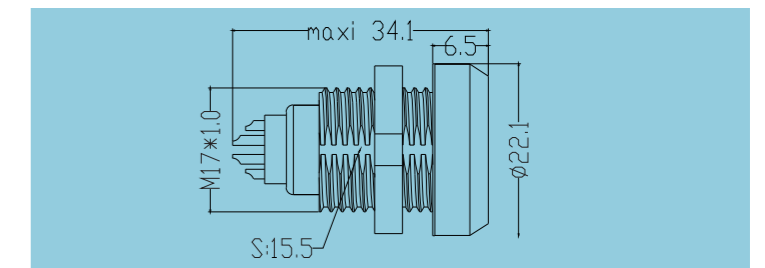

2P CKB Fixed socket



Receptacle, with two nuts fixing,(back panel mounting)

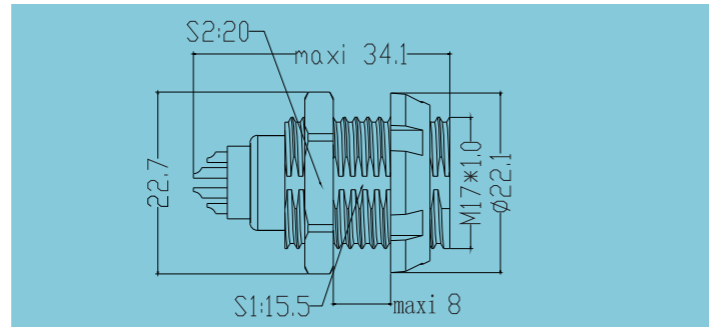

2P CKB Fixed socket

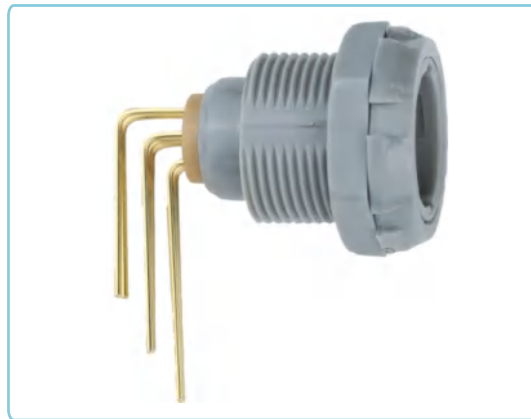

Fixed receptacle with two nuts, with 90° contacts for printed circuit (back panel mounting)

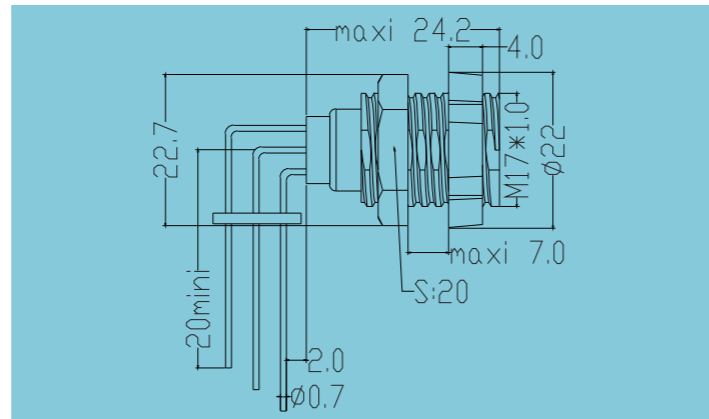

2P CLB Fixed socket



Receptacle, nut fixing,(back panel mounting)

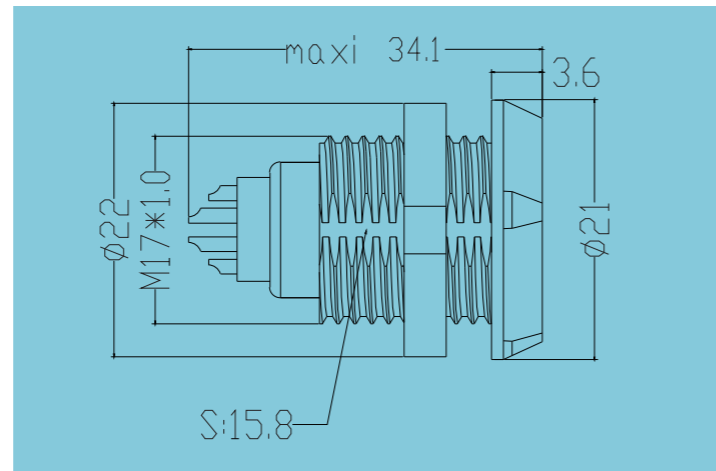

0P PAG Straight plug



With cable collet and nut for fitting a bend relief

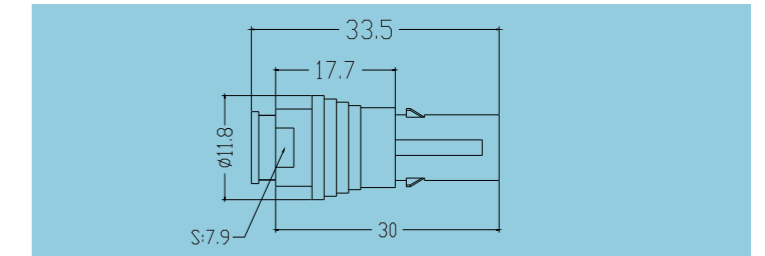

0P PKG Fixed socket

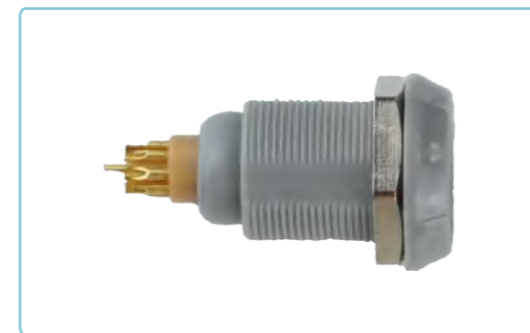

Receptacle with two nuts (back panel mounting)

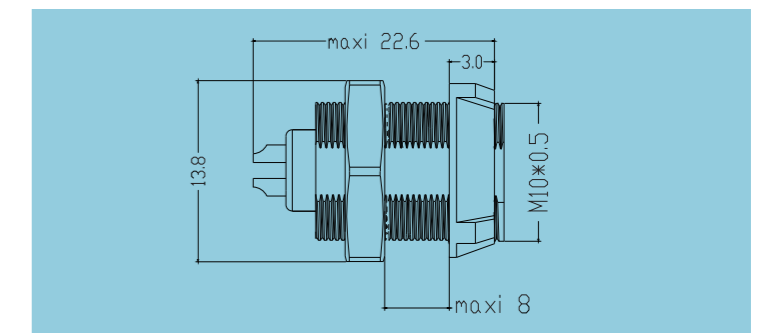

0P PKG Fixed socket



Fixed receptacle with two nuts, with 90° contacts for printed circuit (back panel mounting)

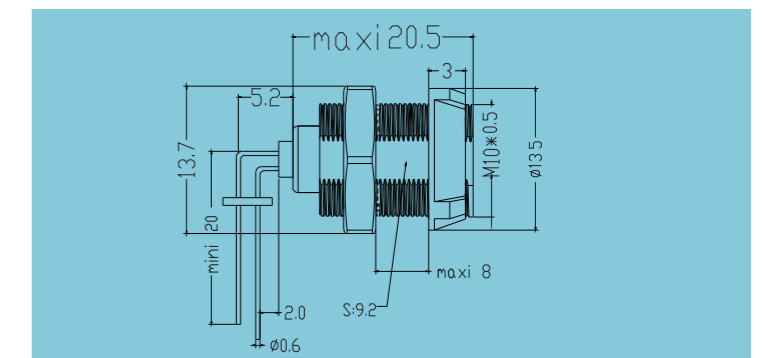

1P socket cap



Multicolor optional

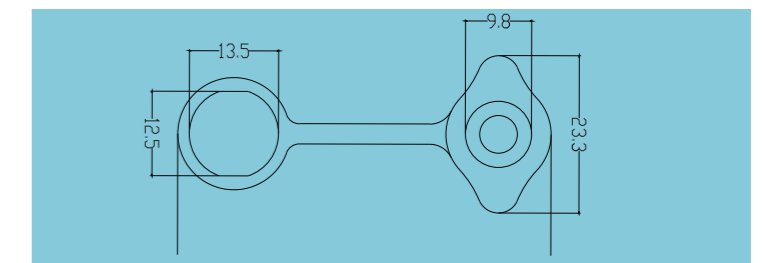

Alignment Key

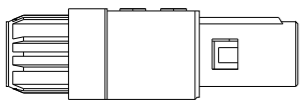
Key of plug	Picture Sample			
	0°	40°	60°	80°
Ref.	G	A	B	C

Color of nut

Color Table

Color	Blue	Gray	Yellow	Black	Red	Green
Ref.	A	G	J	N	R	V

Collet

Ref.	∅ cable
42	3.5-4.5
52	4.5-5.5
62	5.5-6.5

An illustrative

P series plug and socket separation instruction

When the plug and socket are plugged in, pinch the plug shell with the pattern with your thumb and forefinger (as indicated by the red arrow in picture 1), and then pull the plug along the end of the plug (as indicated by the green arrow in picture 1) to separate it (as shown in picture 2).
Note: It is not necessary to twist the plug to separate from the socket.

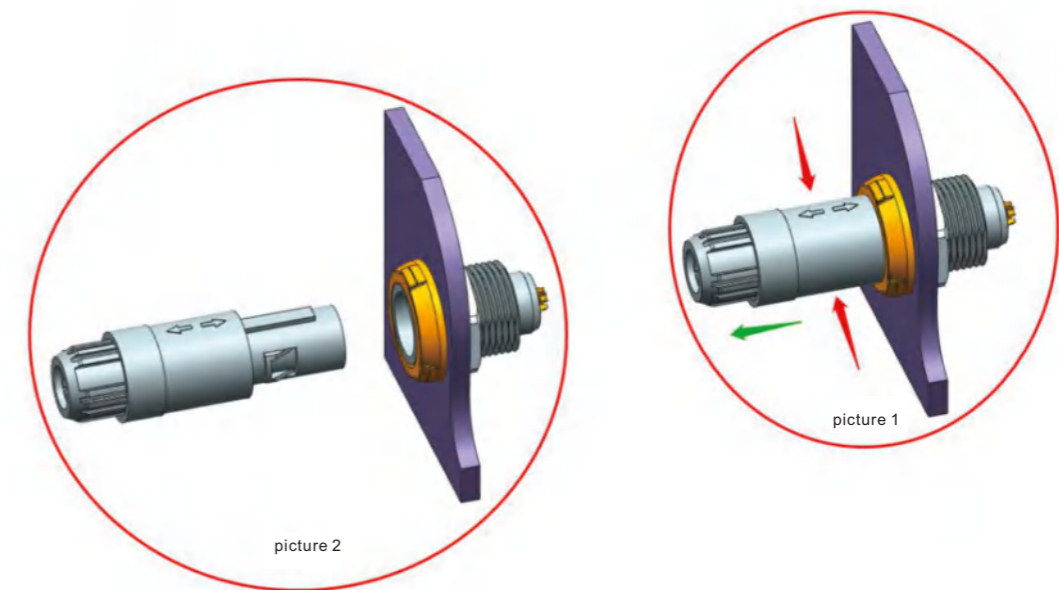

P series plug decomposition diagram

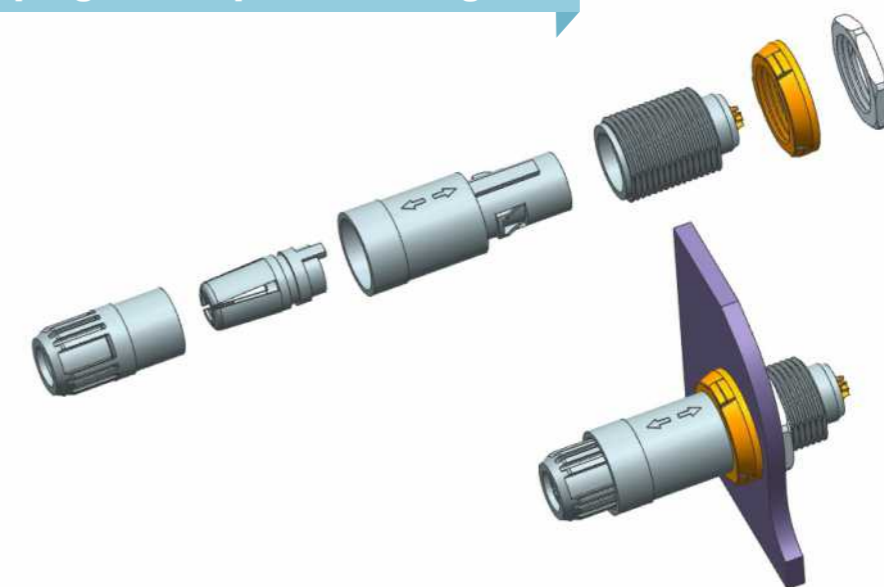



W series

W series connector technical features

All W series models are waterproof when plugged in, and the fixed socket end can meet the vacuum seal. W series adopts threaded connection, and when correctly assembled with the corresponding cable, it can meet the waterproofing requirements under 50 meters of water. After cable assembly, the rear part must be covered by an adhesive heatshrink boot in order to ensure watertightness on the cable side.

W series connectors provide the following main features:

- Threaded connections.
- Multipole types from 2 to 32 contacts.
- Solder or print contacts.
- Waterproof(IP68).
- 360° screening for full EMC shielding.
- Rugged housing for extreme working conditions.
- Keying system («G» key standard) for connector alignment.

Part Numbering System of W series

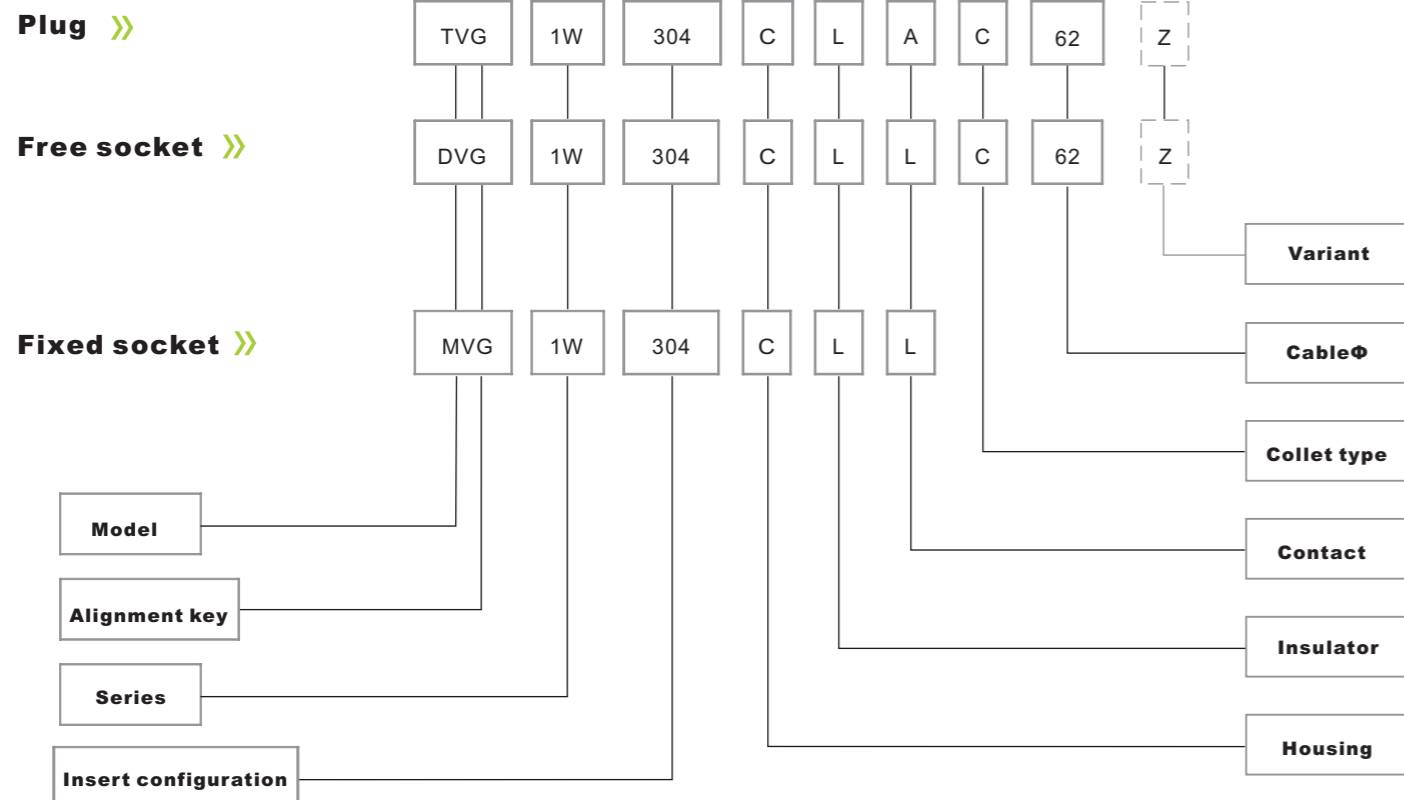

Part Number Example

▲ Straight plug with cable collet:

TVG.1W.310.CLAC62 = straight plug with key (G), 1W series, multipole type with 10 contacts, outer shell in chrome-plated brass, PPS insulator, male solder contacts, C type collet for 6.2 mm diameter cable.

▲ Free socket:

DVG.1W.310.CLAC62 = free socket, key (G), 1W series, multipole type with 10 contacts, outer shell in chrome-plated brass, PPS insulator, female solder contacts, C type collet for 6.2 mm diameter cable.

▲ Fixed socket:

MVG.1W.310.CLL = fixed socket, vacuumtight, nut fixing, key (G), 1W series, multipole type with 10 contacts, outer shell in chrome-plated brass, PPS insulator, female solder contacts.

Part Section Showing Internal Components

Fixed socket

- ① outer shell
- ② O-ring
- ③ hexagonal nut
- ④ retaining ring
- ⑤ insulator
- ⑥ female contact

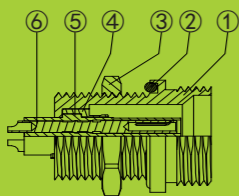

Straight plug

- ① hexagon nut shell
- ② outer shell
- ③ o-ring
- ④ earthing cone
- ⑤ retaining ring
- ⑥ male contact
- ⑦ collet nut
- ⑧ collet

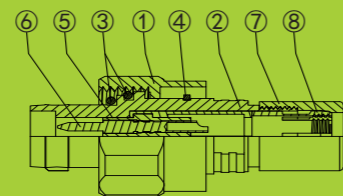

TVG Straight plug



key (G) or keys (A, B or L), cable collet and nut for fitting a bend relief

Reference		Dimensions (mm)							
Series	Model	A	B	L	M	N	S1	S2	
0W	TVG	17.2	8.9	35.5	30.8	13.5	16	8	
1W	TVG	19.3	11.0	43.7	35.5	14.0	18	9	
2W	TVG	23.5	14.0	52.5	43.0	15.5	22	12	
3W	TVG	27.8	17.0	61.5	48.0	16.5	26	15	

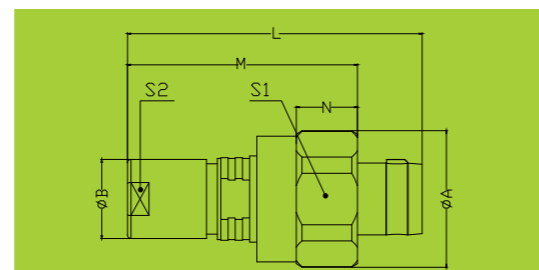

MVG Fixed socket

nut fixing, key (G) or keys (A, B or L), vacuumtight

Reference		Dimensions (mm)										
Series	Model	A	B	e	e1	E	L	N	S1	S2	S3	
0W	MVG	16.2	16.0	M12x1.0	M14x1.0	4.0	22.1	8.0	10.5	12.5	14	
1W	MVG	18.3	19.5	M14x1.0	M16x1.0	8.0	26.0	8.0	12.5	14.5	17	
2W	MVG	22.5	21.8	M16x1.0	M20x1.0	9.0	25.1	9.0	14.5	18.5	19	
3W	MVG	26.6	27.0	M20x1.0	M20x1.0	13.0	34	9.5	18.5	22.5	24	

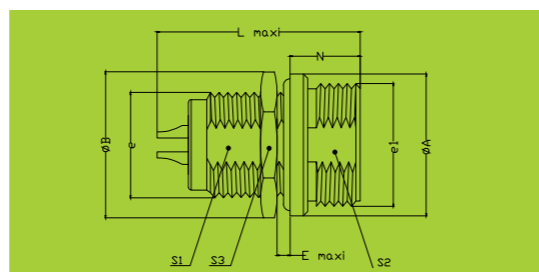

DVG Free socket



key (G) or keys (A, B or L), cable collet and nut for fitting a bend relief

Reference		Dimensions (mm)							
Series	Model	A	B	e	L	S1	S2	S3	
0W	TVG	16.2	8.9	M14x1.0	34.0	14	13.5	7	
1W	TVG	18.3	11.0	M16x1.0	45.0	16	14.5	9	
2W	TVG	22.5	14.0	M20x1.0	54.0	20	18.5	12	
3W	TVG	26.6	17.0	M24x1.0	64.0	24	22.5	15	

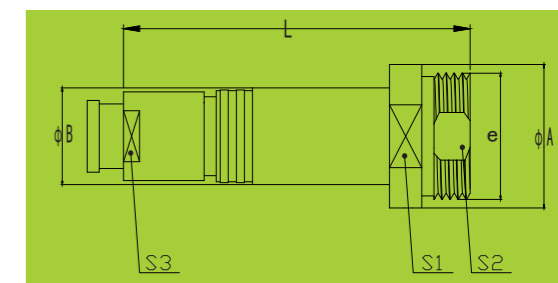

An illustrative

W series plug and socket separation instruction

Plugging method: In the separated state, align the plug with the key and insert (1) into the socket. Tighten the connecting nut (2) clockwise to insert and lock.
Separation method: when inserted, unscrew (3) connecting nut counterclockwise, and then unscrew (4) to separate.

Separation of state

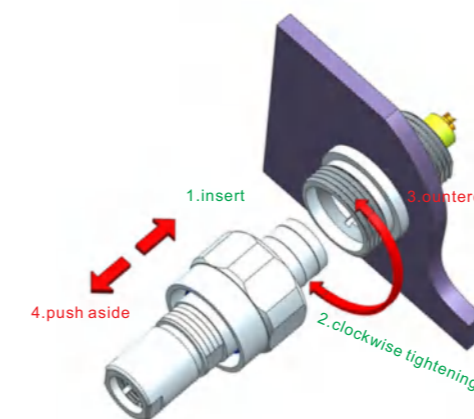

Insert or state





T series

T series connectors have been specifically designed for outdoor applications.

All models of this series are watertight when mated to give a protection index of IP68 (IP66 otherwise) when correctly assembled to an appropriate cable. K series connectors have the same insulators as the B series and have the following main features:

- Security of the Push-Pull latching system.
- High packing density for space savings.
- 360° screening for full EMC shielding .
- Keying system («G» key standard) .
- Multipole types 2 to 32 contacts .
- Watertight connection (IP 68/IP 66).
- Solder or print (straight or elbow) contacts.
- Multiple key options to avoid cross mating for connector alignment of similar connectors.
- Rugged housing for extreme working conditions.

Part Numbering System of T series

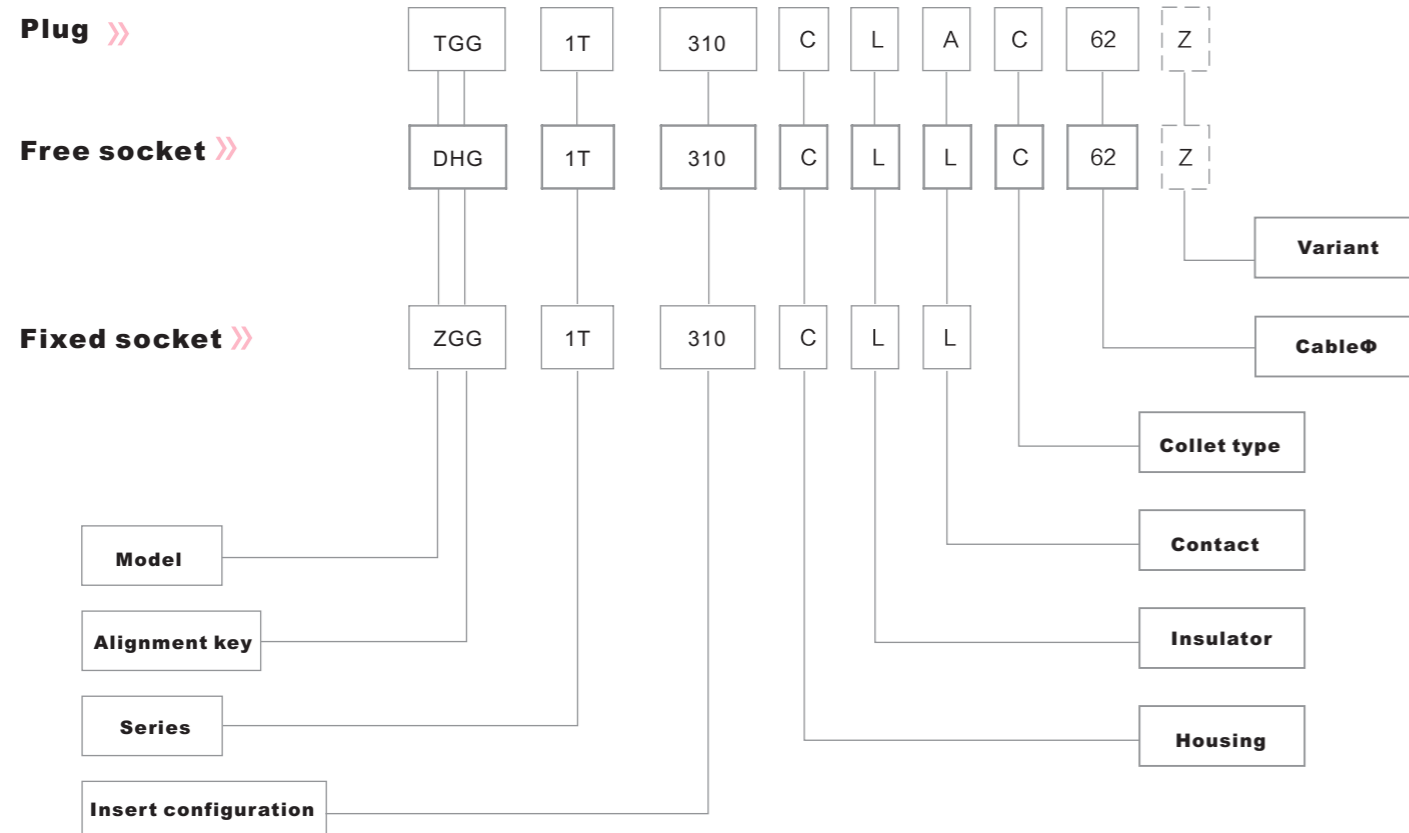

Technical Characteristics of T series:

Mechanical and Climatical:

- Endurance: > 5000 cycles.
- Humidity: up to 95% at 60°C.
- Temperature range: - 55°C, + 250°C.
- Resistance to vibrations: 10-2000 Hz, 15g.
- Shock resistance: 100g, 6ms.
- Salt spray corrosion test: > 48h.
- Protection index (mated): IP 66~68.

Housings (B T and K series)

Ref.	Outer shell and collet nut		Latch sleeve + earthing crown		Other metallic components	
	Material	Surf. treatment	Material	Surf. treatment	Material	Surf. treatment
C	Brass	chrome	brass/bronze	nickel	brass	nickel
N	Brass	nickel	brass/bronze	nickel	brass	nickel
K	Brass	black chrome	brass/bronze	nickel	brass	nickel
S	Stainless steel	—	brass/bronze	nickel	brass	nickel
T	Stainless steel	—	Stainless steel	nickel	brass	nickel
U	Stainless steel	—	Stainless steel	nickel	Stainless steel	nickel
L	Aluminium alloy	anodized	brass/bronze	nickel	brass	nickel
X	Aluminium alloy	nickel anthracite	brass/bronze	nickel	brass	nickel

Note: In the B T and K series, the latch sleeve is nickel-plated.

Examples of Product Numbers

▲ Straight plug with cable collet:

TGG.1T.310.CLAC62 = straight plug with key (G) and cable collet, 1T series, multipole type with 10 contacts, outer shell in chrome-plated brass, PPS insulator, male solder contacts, C type collet for 6.2 mm diameter cable.

▲ Fixed socket:

ZGG.1T.310.CLL = fixed socket, nut fixing, with key (G), 1T series, multipole type with 10 contacts, outer shell in chrome-plated brass, PPS extended insulator, female solder contacts.

Part Section Showing Internal Components

Fixed socket

- ① outer shell
- ② O-ring
- ③ locking washer
- ④ hexagonal nut
- ⑤ earthing crown
- ⑥ insulator
- ⑦ female contact

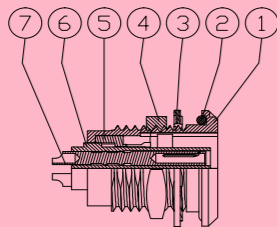

Straight plug

- ① outer shell
- ② latch sleeve
- ③ retaining ring washer
- ④ o-ring
- ⑤ end cap gasket
- ⑥ insulator
- ⑦ male contact
- ⑧ collet nut
- ⑨ collet

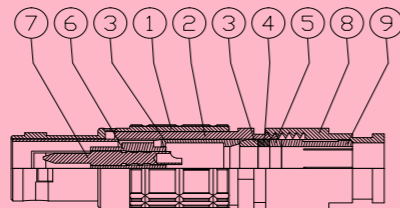

TGG Straight plug

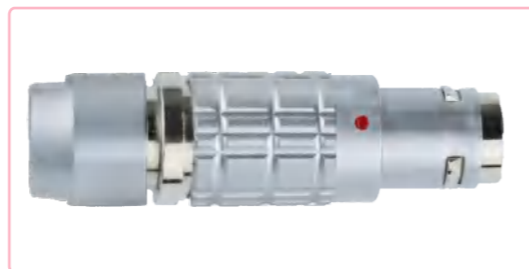

key (G) or keys (A...F,L or R),cable collet

Reference		Dimensions (mm)		
Series	Model	A	L	M
0T	TGG	9.0	39.0	29.0
1T	TGG	12.0	46.0	35.0
2T	TGG	15.0	55.0	43.0

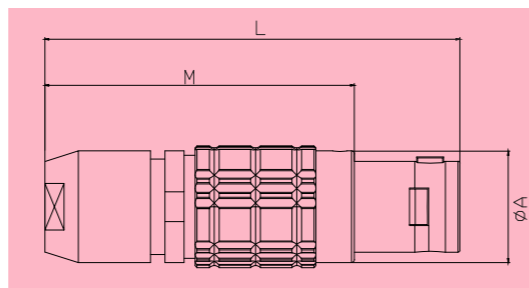

TGG Straight plug

key (G) or keys (A...F,L or R),cable collet and nut for fitting a bend relief

Reference		Dimensions (mm)		
Series	Model	A	L	M
0T	TGG	9.0	38.0	28.0
1T	TGG	12.0	45.0	34.0
2T	TGG	15.0	54.0	42.0

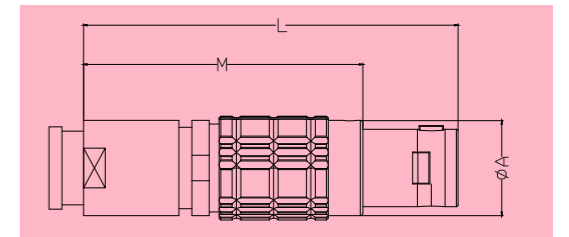
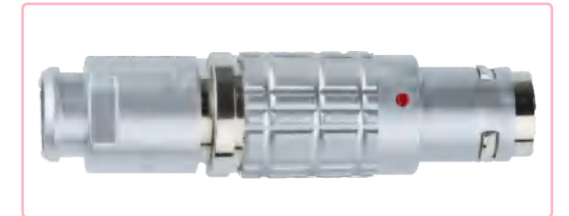

ZGG Fixed socket



key (G) or keys (A...F,L or R),nut fixing

Reference		Dimensions (mm)					
Series	Model	A	e	E	L	M	N
0T	ZGG	12.0	M9X0.6	6.0	21.0	1.5	19.1
1T	ZGG	15.5	M12X1.0	6.0	23.0	1.8	21.5
2T	ZGG	18.5	M15X1.0	7.5	26.5	1.8	24.6

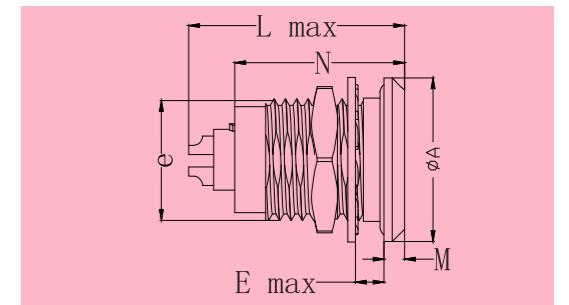

ZEG Fixed socket

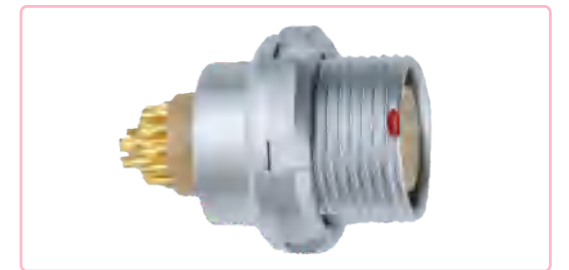

key (G) or keys (A...F,L or R),nut fixing, back panel mounting

Reference		Dimensions (mm)				
Series	Model	A	e	E	L	N
0T	ZEG	12.0	M9X0.6	6.5	21.0	19.1
1T	ZEG	15.5	M12X1.0	6.0	23.0	21.5
2T	ZEG	18.5	M15X1.0	7.5	26.5	24.6

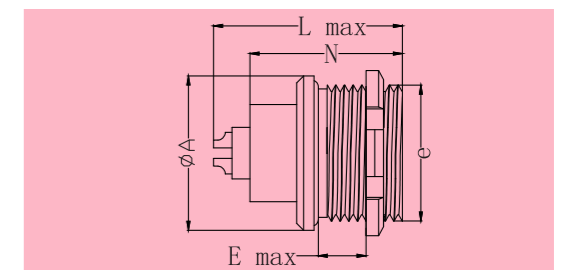



HR10A series

HR10A series connectors have main features as follows:

HR10A miniature push-pull self-locking circular connector is widely used in electronic instruments, industrial cameras, visual equipment, cameras, medical equipment and so on.

The features of the product are:

- Push-pull self-locking connection, connection separation is simple and fast. (Shell surface anti-skid design, sound prompt when self-locking).
- Exquisite self-locking device ensures firm and reliable connection.
- The use of reasonable five keys design with complete anti-blind insert function.
- Compact structure design. (Can effectively save the equipment space, the micro design of the equipment implementation).
- Nickel plated copper plug shell, nickel plated zinc alloy socket shell, PPS insulator.

Examples of Product Numbers:

- HR10A-7P-4P=NO.1 series, straight plug of 7# shell size, multipole type with 4 contacts, male solder contacts.
- HR10A-7R-4S=NO.1 series, fixed socket of 7# shell size, multipole type with 4 contacts, female solder contacts.
- HR10A-7J-4S=NO.1 series, free socket of 7# shell size, multipole type with 4 contacts, female solder contacts.

Part Numbering System of HR10A series

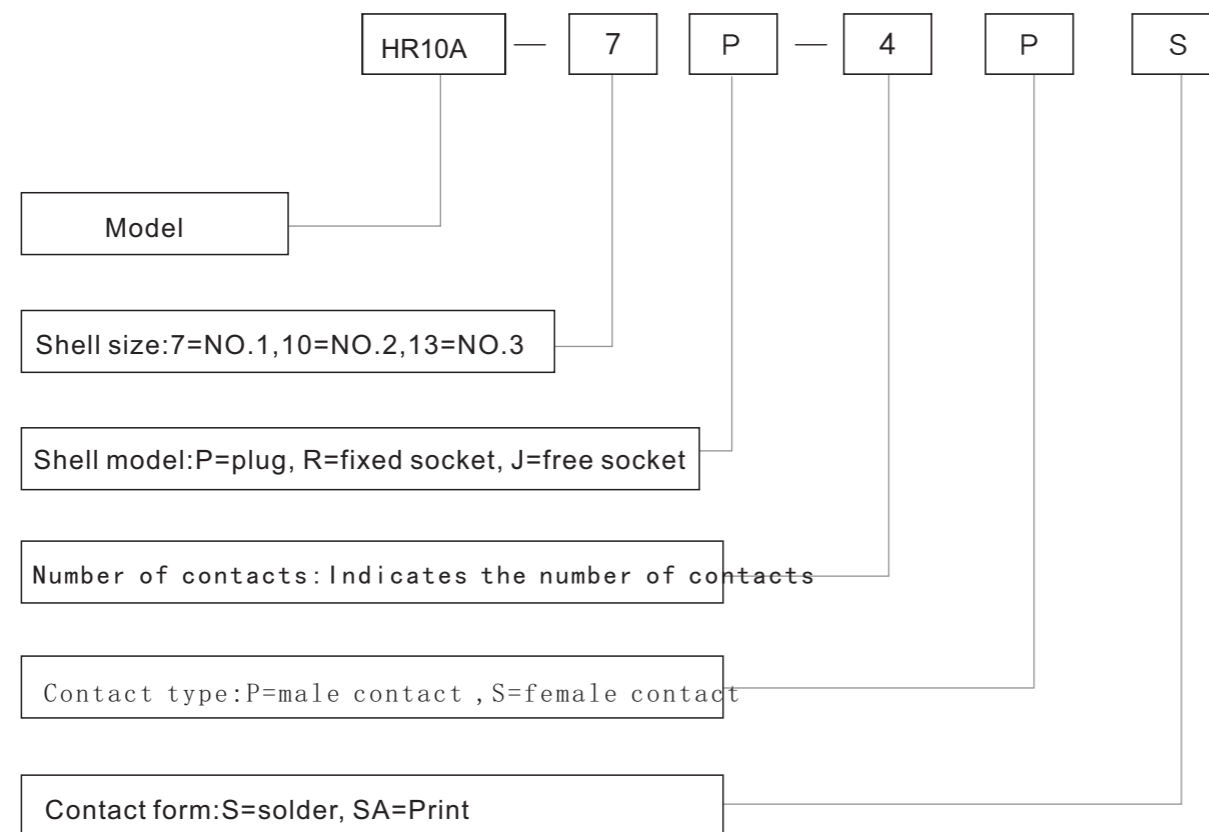

Part Section Showing Internal Components

Fixed socket

- ① male contact
- ② male insulator
- ③ hexagonal nut
- ④ gasket
- ⑤ shell
- ⑥ lock the shell

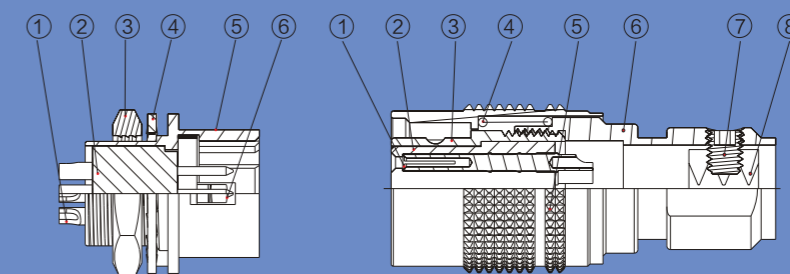

Straight plug

- ① female contact
- ② female insulator
- ③ inner shell
- ④ pressure spring
- ⑤ outer shell
- ⑥ cable sets
- ⑦ screw
- ⑧ U clamp

Fixed socket(solder)

Shell Size	A	B	C	D	S1	S2
1#	14	11	8.8	M8*0.5	7.2	10
2#	15.6	14	10.9	M11*0.75	10	13
3#	20.5	18	15.3	M14*1.0	13.1	17

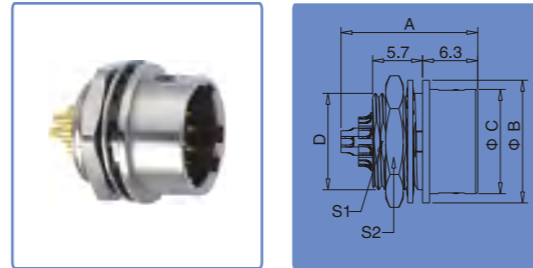

Fixed socket(print)

Shell Size	A	B	C	D	S1	S2
1#	15.5	11	8.8	M8*0.5	7.2	10
2#	15.5	14	11.9	M11*0.75	10	13
3#	20.5	18	15.3	M14*1.0	13.1	17

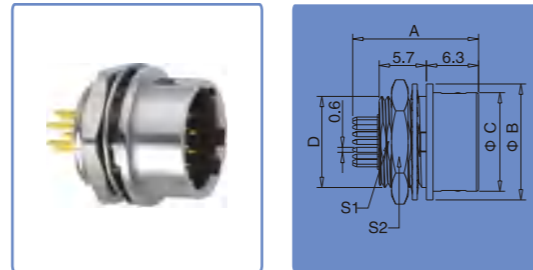

Straight plug

Shell Size	A	B	C
1#	35	11.5	8.8
2#	43	14	10.9
3#	43	19	13

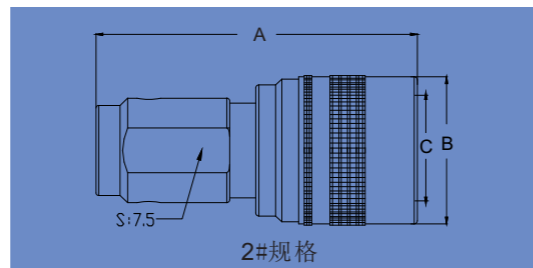

HR10A series free socket

Shell Size	A	B	C
1#	32.8	11.5	8.8
2#	43.9	14.5	11.8

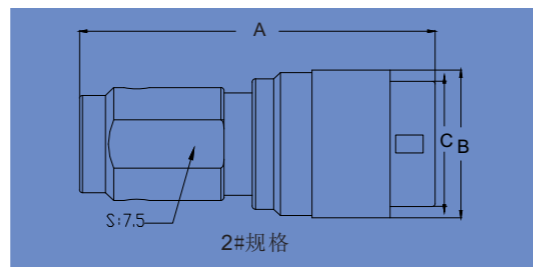

Threaded fixed socket

Shell Size	A	B	C	D
1#	14.9	11.4	M10*0.75	M8*0.5
2#	17.5	15.5	M13*0.75	M11*0.75

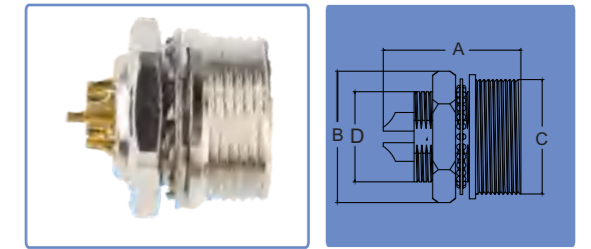

Threaded straight plug

Shell Size	A	B
1#	26.5	12
2#	32	17

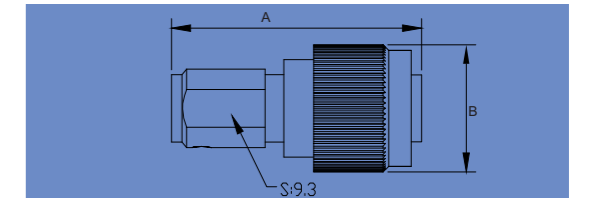
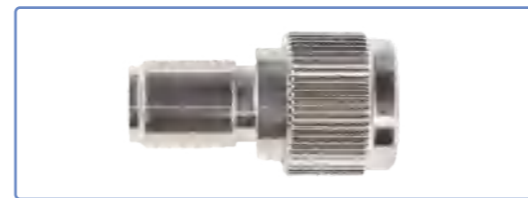

Threaded free socket

Shell Size	A	B	C
1#	26	11	M10*0.75
2#	30.5	15	M13*0.75

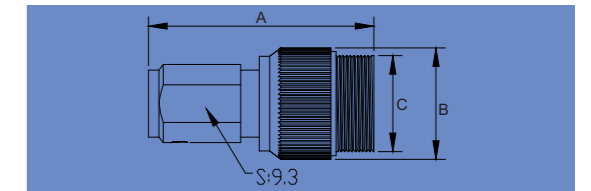

Threaded fixed socket(waterproof)

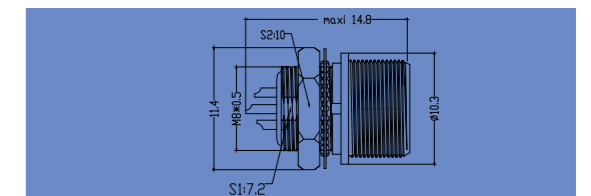

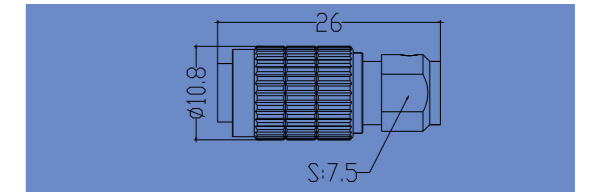

Threaded straight plug(waterproof)

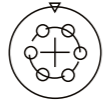
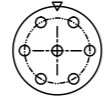
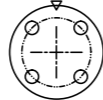
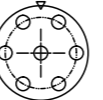
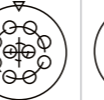
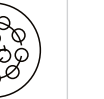

Technical parameters

Insulator hole arrangement

NO.	Performance indicators	Shell 1#				Shell 2#			
									
1	Contact ø(mm)	0.5mm				0.9mm	0.7mm	0.5mm	
2	Adapter cable	26AWG				22AWG	24AWG	26AWG	
3	Test voltage (kV rms)	Contact -contact	0.95KV	0.80KV	0.75KV	1.45KV	1.25KV	1.15KV	0.95KV
		Contact -shell	0.80KV	0.70KV	0.65KV	1.30KV	1.35KV	1.35KV	1.25KV
4	Rated current (A)	2A				8A	7A	2A	
	Temperature range(°C)	-50°C~125°C				-50°C~125°C			
5	Endurance(cycles)	1000				1000			

Keys change

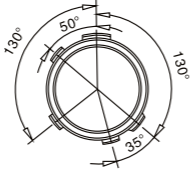
(Plug) Key	
contact of plug	Female/Male
contact of socket	Female/Male
number of contact	4、6、7、10、12

PCB drilling pattern

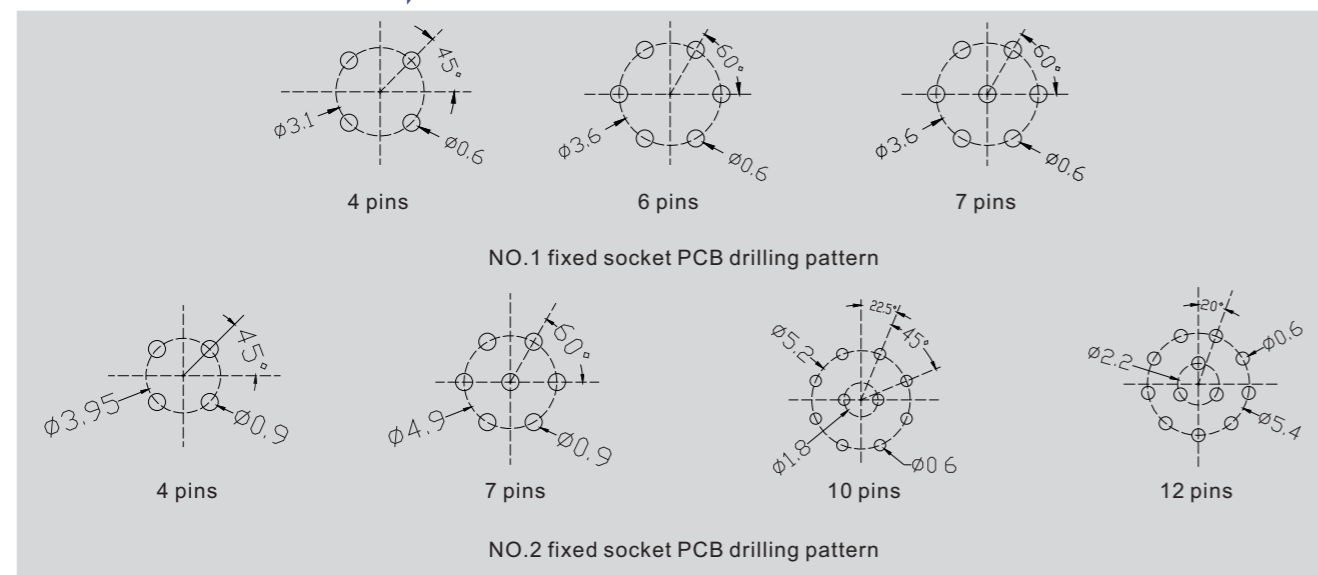

Panel cut-outs

Shell Size	D	T	L
1	8.0	1.6	9.0
2	11.1	2.5	11.5
3	14.2	2.6	15.5

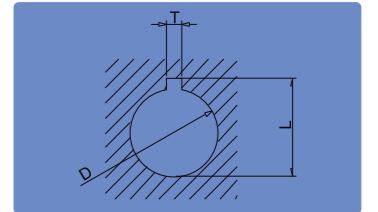

An illustrative

HR10A series plug and socket separation instruction

When the plug and socket are plugged in, pinch the plug shell with the pattern with your thumb and forefinger (as indicated by the red arrow in picture 1), and then pull the plug along the end of the plug (as indicated by the green arrow in picture 1) to separate it (as shown in picture 2). Note: It is not necessary to twist the plug to separate from the socket.

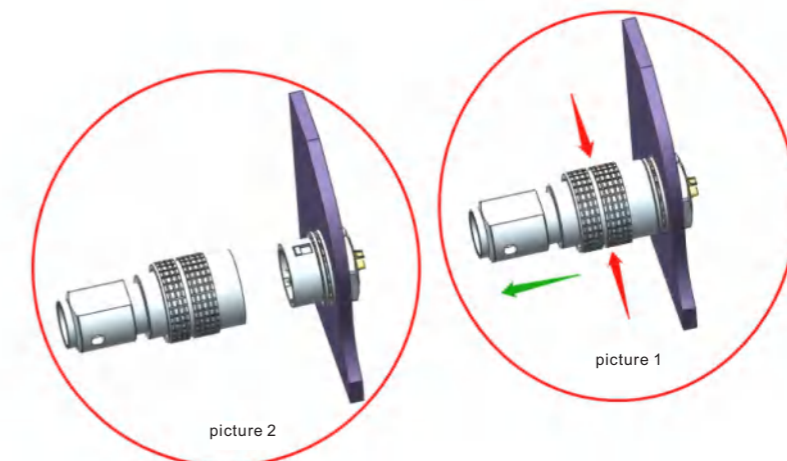

HR10A series plug decomposition diagram

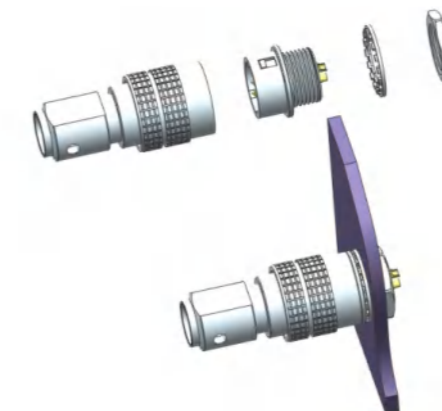

Insert configuration

	Solder contacts(male)	Solder contacts(female)
00B		
0B 0K 0F 0W 0T		
1B 1K 1F 1W 1T		

- First choice alternative
- Special order alternative

Reference	NO. of contact	Φ A (mm)	Contact type			Solder		Rated current (A)
			Solder contact	Print (straight)	Print (elbow)	Test voltage (kV rms) Contact -contact	Test voltage (kV rms) Contact -shell	
302	2	0.5	●	●	●	1.00	0.95	5.0
303	3	0.5	●	●	●	0.80	0.95	3.0
304	4	0.5	●	●	●	0.80	0.65	2.0
305	5	0.35	●	●	●	0.70	1.00	1.7
302	2	0.9	●	●	●	1.00	1.05	10.0 ₍₁₎
303	3	0.9	●	●	●	1.20	0.90	8.0 ₍₁₎
304	4	0.7	●	●	●	0.85	0.70	7.0 ₍₁₎
305	5	0.7	●	●	●	1.00	0.70	6.5 ₍₁₎
306	6	0.5	●	●	●	0.85	0.65	2.5
307	7	0.5	●	●	●	0.80	0.70	2.5
309	9	0.5	●	●	○	0.60	0.50	2.0
302	2	1.3	●	●	●	1.50	1.35	15.0 ₍₂₎
303	3	1.3	●	●	●	1.30	1.55	12.0
304	4	0.9	●	●	●	1.35	1.45	10.0 ₍₁₎
305	5	0.9	●	●	●	1.25	1.15	9.0 ₍₁₎
306	6	0.7	●	●	●	1.05	1.20	7.0 ₍₁₎
307	7	0.7	●	●	●	0.95	1.05	7.0 ₍₁₎
308	8	0.7	●	●	●	0.95	1.15	5.0
310	10	0.5	●	●	●	0.90	1.50	2.5
312	12	0.5	●	●	●	0.85	1.15	2.0
314	14	0.5	●	●	●	0.80	1.20	2.0
316	16	0.5	●	●	○	0.80	1.25	1.5

Note: (1) rated current = 6A for socket with elbow (90°) contact for printed circuit.
 (2) rated current = 12A for socket with elbow (90°) contact for printed circuit.
 (3) available only for connectors fitted with male contacts.

	Solder contacts(male)	Solder contacts(female)
2B 2K 2W 2T		

- First choice alternative
- Special order alternative

Reference	NO. of contact	Φ A (mm)	Contact type			Solder		Rated current (A)
			Solder contact	Print (straight)	Print (elbow)	Test voltage (kV rms) Contact -contact	Test voltage (kV rms) Contact -shell	
302	2	2.0	●	●	●	2.10	1.75	30.0 ₍₂₎
303	3	1.6	●	●	●	2.40	1.85	17.0 ₍₂₎
304	4	1.3	●	●	●	1.85	1.85	15.0 ₍₂₎
305	5	1.3	●	●	●	1.75	1.60	14.0 ₍₂₎
306	6	1.3	●	●	●	1.35	1.45	12.0
307	7	1.3	●	●	●	1.75	1.60	11.0
308	8	0.9	●	●	●	1.50	1.25	10.0 ₍₁₎
310	10	0.9	●	●	●	1.45	1.30	8.0 ₍₁₎
312	12	0.7	●	●	●	1.25	1.35	7.0 ₍₁₎
314	14	0.7	●	●	●	1.15	1.35	6.5 ₍₁₎
316	16	0.7	●	●	●	0.95	1.25	6.0
318	18	0.7	●	●	●	0.85	1.20	5.5
319	19	0.7	●	●	●	0.95	1.25	5.0
326	26	0.5	●	●	○	0.95	1.30	2.0
332		0.5	●	●	○	0.80	1.20	1.5

Note: (1) rated current = 6A for socket with elbow (90°) contact for printed circuit.
 (2) rated current = 12A for socket with elbow (90°) contact for printed circuit.

	Solder contacts(male)		Solder contacts(female)		Reference	NO. of contact	Φ A (mm)	Contact type			Solder		Rated current (A)
			Solder contact	Print (straight)				Print (elbow)	Test voltage (kV rms) Contact -contact	Test voltage (kV rms) Contact -shell			
3B 3K 3W 3T			●	●	—	2	3.0	●	●	—	2.10	1.55	35.0
			●	●	○	3	2.0	●	●	○	1.90	1.50	25.0
			●	●	○	4	2.0	●	●	○	1.45	1.25	19.0
			●	●	○	5	1.6	●	●	○	1.90	1.25	19.0
			●	●	○	6	1.6	●	●	○	1.60	1.15	17.0
			●	●	○	7	1.6	●	●	○	1.70	1.25	15.0
			●	●	○	8	1.3	●	●	●	1.65	1.15	13.0
			●	●	○	10	1.3	●	●	○	1.25	0.90	15.0
			●	●	●	12	0.9	●	●	●	1.45	1.00	12.0
			●	●	●	14	0.9	●	●	●	1.20	1.20	9.0
			●	●	●	16	0.9	●	●	●	1.20	0.85	9.0 ₍₁₎
			●	●	●	18	0.9	●	●	●	1.20	1.05	8.0

- First choice alternative
- Special order alternative

Note:(1)rated current = 6A for socket with elbow (90°) contact for printed circuit.
 (2) rated current = 12A for socket with elbow (90°) contact for printed circuit.
 (3) available only for connectors fitted with male contacts.

	Solder contacts(male)		Solder contacts(female)		Reference	NO. of contact	Φ A (mm)	Contact type			Solder		Rated current (A)		
			Solder contact	Print (straight)				Print (elbow)	Test voltage (kV rms) Contact -contact	Test voltage (kV rms) Contact -shell					
3B 3K 3W 3T			●	●	○	20	0.7	●	●	○	1.00	0.90	6.0		
			●	●	○	20	0.7	●	●	○	1.00	0.90	6.0		
			●	●	○	22	0.7	●	●	○	1.00	0.90	6.0		
			●	●	○	24	0.7	●	●	○	0.95	0.80	4.0		
			●	●	○	26	0.7	●	●	○	0.95	0.70	4.0		
			●	●	○	27	0.7	●	●	○	0.90	0.70	3.5		
			●	●	○	30	0.7	●	●	○	0.80	0.70	3.5		
			●	●	○	32	0.7	●	●	○	0.80	0.70	3.0		
			●	●	●	0S	0E	2	0.9	●	●	●	1.1	1.6	10
			●	●	●	0S	0E	3	0.7	●	●	●	1.0	1.5	7
			●	●	●	0S	0E	4	0.7	●	●	●	1.0	1.5	7
			●	●	●	1S	1E	2	1.3	●	●	●	1.2	1.8	15
			●	●	●	1S	1E	3	0.9	●	●	●	1.2	1.8	10
			●	●	●	1S	1E	4	0.9	●	●	●	1.2	1.8	10
		●	●	●	1S	1E	2 3	0.9 0.7	●	●	●	1.5 1.5	2.1 2.1	10 7	
		●	●	●	1S	1E	6	0.7	●	●	●	1.2	1.7	7	

- First choice alternative
- Special order alternative

Note:(1)rated current = 6A for socket with elbow (90°) contact for printed circuit.
 (2) rated current = 12A for socket with elbow (90°) contact for printed circuit.
 (3) available only for connectors fitted with male contacts.

	Solder contacts(male)	Solder contacts(female)	Reference	NO. of contact	Φ A (mm)	Contact type			Solder		Rated current (A)	
						Solder contact	Print (straight)	Print (elbow)	Test voltage (kV rms) Contact-contact	Test voltage (kV rms) Contact-shell		
0P			302	2	0.9	●	●	●	1.0	1.05	10.0 ₁₎	
			303	3	0.9	●	●	●	1.20	0.90	8.0 ₁₎	
			304	4	0.7	●	●	●	0.85	0.70	7.0 ₁₎	
			305	5	0.7	●	●	●	1.00	0.70	6.5 ₁₎	
			306	6	0.5	●	●	●	0.85	0.65	2.5	
			307	7	0.5	●	●	●	0.80	0.70	2.5	
			309	9	0.5	●	●	○	0.60	0.50	2.0	
	1P			301	1	3.0	●	-	-	1.75	1.75	15.0
				302	2	1.3	●	●	●	1.20	1.30	10.0
			303	3	1.3	●	●	●	1.20	1.20	10.0	
			304	4	0.9	●	●	●	1.20	1.20	8.0	
			305	5	0.9	●	●	●	1.05	0.80	7.0	
			306	6	0.7	●	●	●	1.05	0.85	6.0	
			307	7	0.7	●	●	●	1.05	0.85	5.0	
			308	8	0.7	●	●	●	1.05	0.60	5.0	
			309	9	0.5	●	●	●	0.85	0.60	3.0	
			310	10	0.5	●	●	●	0.85	0.45	3.0	
			314	14	0.5	●	●	●	0.60	0.50	2.0	

- First choice alternative
- Special order alternative

Note:(1)rated current = 6A for socket with elbow (90°) contact for printed circuit.
 (2) rated current = 12A for socket with elbow (90°) contact for printed circuit.
 (3) available only for connectors fitted with male contacts.

	Solder contacts(male)	Solder contacts(female)	Reference	NO. of contact	Φ A (mm)	Contact type			Solder		Rated current (A)
						Solder contact	Print (straight)	Print (elbow)	Test voltage (kV rms) Contact-contact	Test voltage (kV rms) Contact-shell	
2P			302	2	2.0	●	●	●	2.10	1.60	30.0 ₂₎
			303	3	1.6	●	●	●	2.40	1.50	17.0 ₂₎
			304	4	1.3	●	●	●	1.85	1.80	15.0 ₂₎
			305	5	1.3	●	●	●	1.75	1.10	14.0 ₂₎
			306	6	1.3	●	●	●	1.35	0.85	12.0
			307	7	1.3	●	●	●	1.75	0.95	11.0
			308	8	0.9	●	●	●	1.50	1.00	10.0 ₁₎
			310	10	0.9	●	●	●	1.45	0.75	8.0 ₁₎
			312	12	0.7	●	●	●	1.25	0.85	7.0 ₁₎
			314	14	0.7	●	●	●	1.50	0.65	6.5 ₁₎
			316	16	0.7	●	●	●	1.50	0.65	6.0
			318	18	0.7	●	●	●	0.85	1.20	5.5
			319	19	0.7	●	●	●	1.40	0.60	5.0
			326	26	0.5	●	●	○	1.00	0.55	2.0
			332	32	0.5	●	●	○	1.00	0.50	2.0

- First choice alternative
- Special order alternative

Note:(1)rated current = 6A for socket with elbow (90°) contact for printed circuit.
 (2) rated current = 12A for socket with elbow (90°) contact for printed circuit.

PCB drilling pattern

Fixed socket with straight print contact (B-K series)

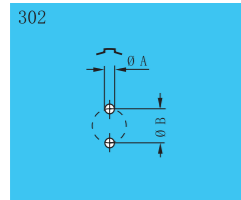

Series	Dimensions(mm)	
	A	B
00	0.6	1.2
0B-0K	0.8	2.2
1B-1K	0.8	2.8
2B-2K	0.8	4.4

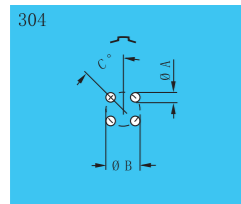

Series	Dimensions(mm)		
	A	B	C
00	0.6	1.6	45°
0B-0K	0.6	2.5	45°
1B-1K	0.8	3.1	45°
2B-2K	0.8	5.0	45°
3B-3K	0.8	6.2	45°

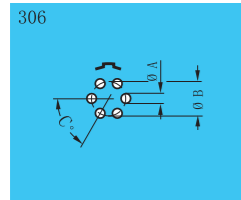

Series	Dimensions(mm)		
	A	B	C
0B-0K	0.6	3.0	60°
1B-1K	0.8	3.7	60°

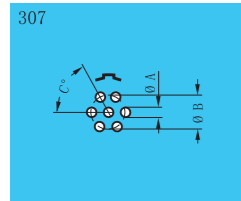

Series	Dimensions(mm)		
	A	B	C
0B-0K	0.6	3.00	60°
1B-1K	0.8	3.70	60°
2B-2K	0.8	5.80	60°
3B-3K	0.8	7.08	60°

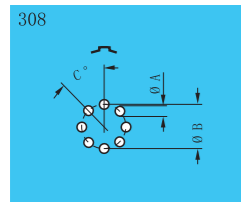

Series	Dimensions(mm)		
	A	B	C
2B-2K	0.8	6.4	45°
3B-3K	0.8	7.5	45°

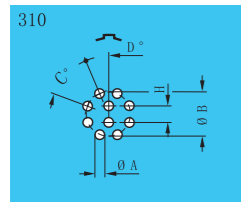

Series	Dimensions(mm)				
	A	B	C	D	H
1B-1K	0.6	3.95	45°	22°30'	1.40
2B-2K	0.8	6.20	45°	22°30'	2.15
3B-3K	0.8	7.90	45°	22°30'	2.80

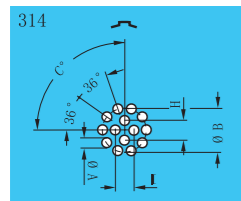

Series	Dimensions(mm)				
	A	B	C	H	I
1B-1K	0.6	4.4	90°	1.90	1.80
2B-2K	0.8	6.5	90°	2.65	2.65
3B-3K	0.8	8.2	90°	3.40	3.40

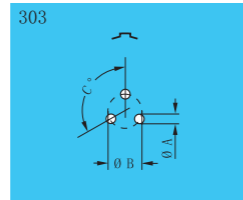

Series	Dimensions(mm)		
	A	B	C
00	0.6	1.35	120°
0B-0K	0.8	2.30	120°
1B-1K	0.8	3.00	120°
2B-2K	0.8	4.60	120°
3B-3K	0.8	5.60	120°

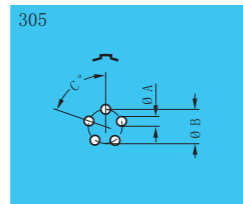

Series	Dimensions(mm)		
	A	B	C
0B-0K	0.6	2.8	72°
1B-1K	0.8	3.4	72°
2B-2K	0.8	5.2	72°
3B-3K	0.8	6.7	72°

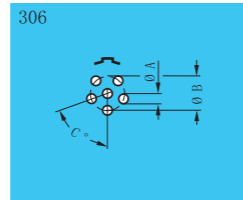

Series	Dimensions(mm)		
	A	B	C
2B-2K	0.8	5.6	72°
3B-3K	0.8	7.1	72°

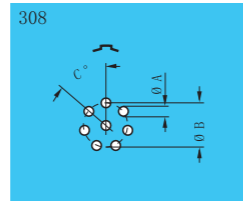

Series	Dimensions(mm)		
	A	B	C
1B-1K	0.8	3.8	51°26'

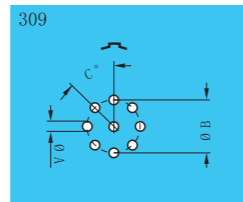

Series	Dimensions(mm)		
	A	B	C
0B-0K	0.6	3.2	45°
3B-3K	0.8	7.5	45°

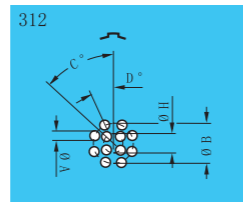

Series	Dimensions(mm)				
	A	B	C	D	H
2B-2K	0.8	6.50	45°	22°30'	2.80
3B-3K	0.8	8.20	45°	22°30'	3.40

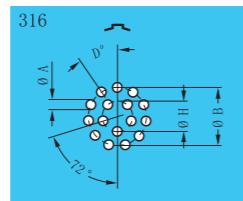

Series	Dimensions(mm)			
	A	B	D	H
1B-1K	0.6	4.4	32°44'	2.00

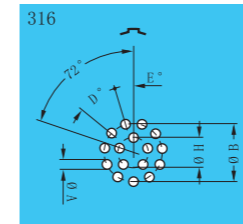

Series	Dimensions(mm)				
	A	B	D	E	H
2B-2K	0.8	6.6	32°44'	16°22'	3.10
3B-3K	0.8	8.4	32°44'	16°22'	3.86
4B-4K	0.6	10.5	32°44'	16°22'	5.00

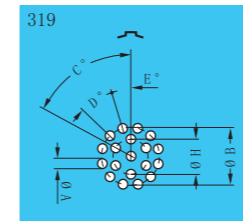

Series	Dimensions(mm)					
	A	B	C	D	E	H
2B-2K	0.8	6.7	60°	30°	15°	3.5

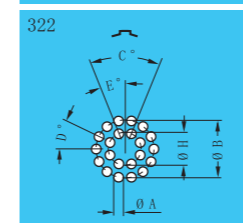

Series	Dimensions(mm)					
	A	B	C	D	E	H
3B-3K	0.6	8.8	45°	25°43'	22°30'	5

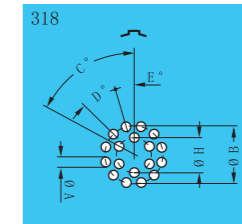
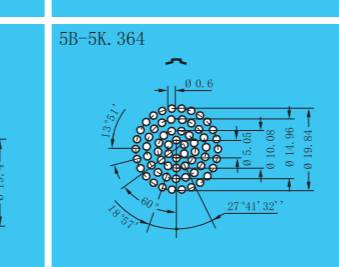
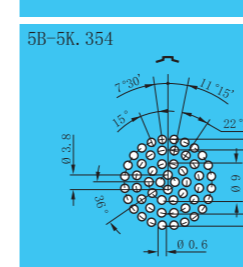
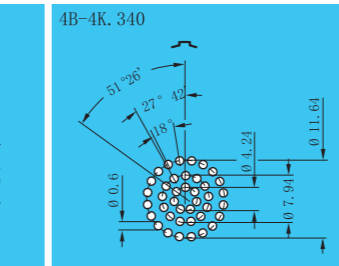
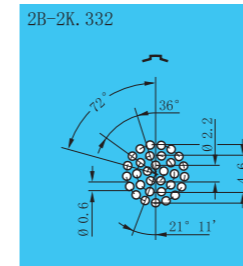
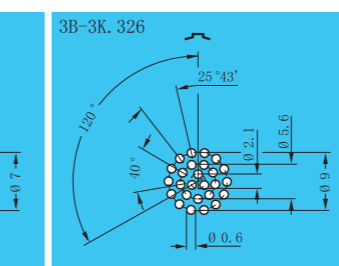
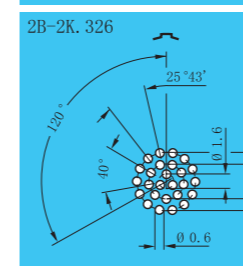

Series	Dimensions(mm)					
	A	B	C	D	E	H
2B-2K	0.8	6.7	60°	30°	15°	3.50
3B-3K	0.8	8.4	60°	30°	15°	4.34

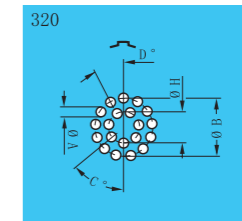

Series	Dimensions(mm)				
	A	B	C	D	H
3B-3K	0.6	8.62	51°26'	27°42'	4.78
4B-4K	0.6	11.00	51°26'	27°42'	6.00

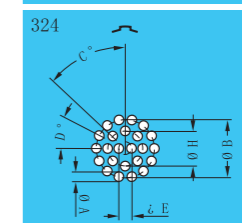

Series	Dimensions(mm)					
	A	B	C	D	E	H
3B-3K	0.6	8.8	45°	25°43'	1.8	5.30
4B-4K	0.6	11.1	45°	25°43'	2.2	6.65

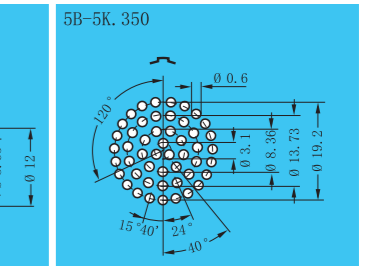
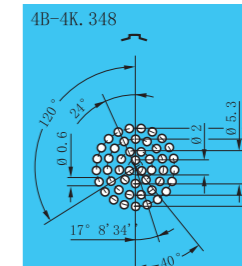
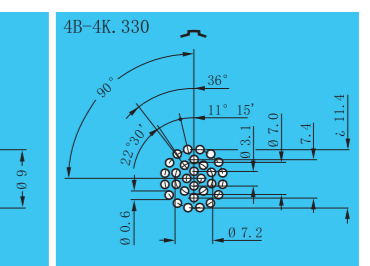
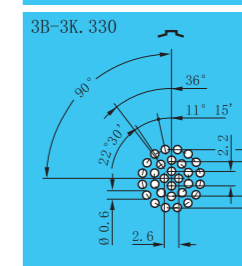

Note: all views are from the side of the socket.

PCB drilling pattern

Fixed socket with elbow print contact (B-K series)

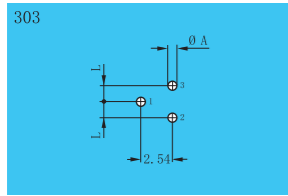
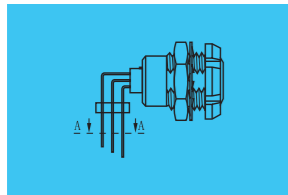

Series	Dimensions(mm)	
	A	L
00	0.6	1.27
0B-0K	0.7	1.27
1B-1K	0.9	1.27
2B-2K	0.9	2.54

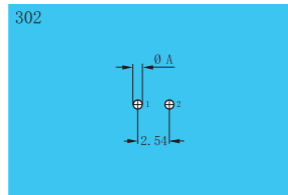

Series	Dimensions(mm)	
	A	L
00	0.6	2.54
0B-0K	0.7	2.54
1B-1K	0.7	2.54
2B-2K	0.9	3.50

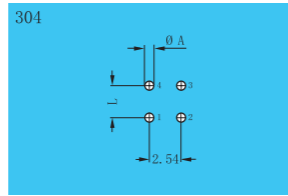

Series	Dimensions(mm)	
	A	L
00	0.6	2.54
0B-0K	0.7	2.54
1B-1K	0.7	2.54
2B-2K	0.9	3.50

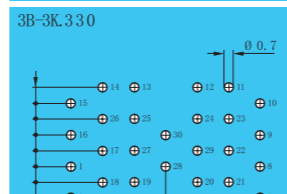
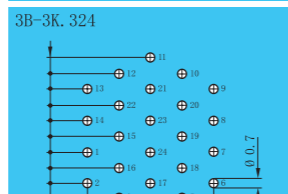
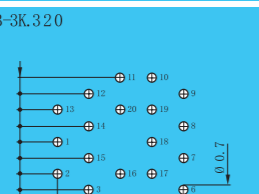
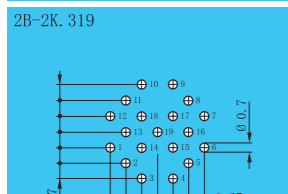
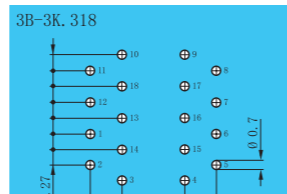
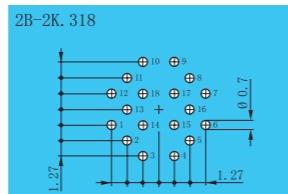
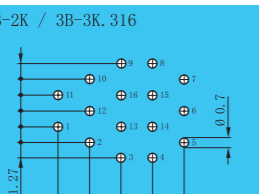
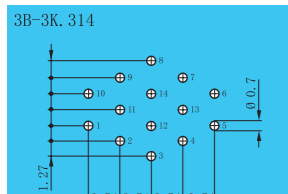
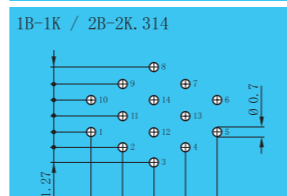
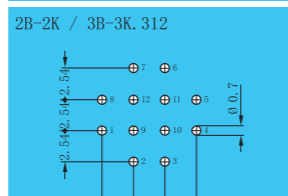
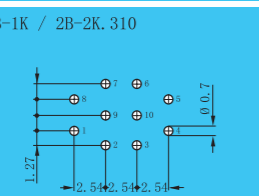
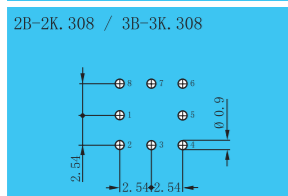
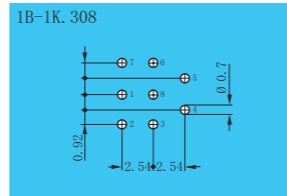
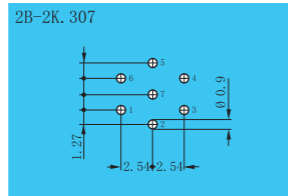
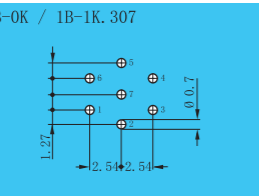
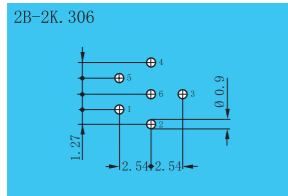
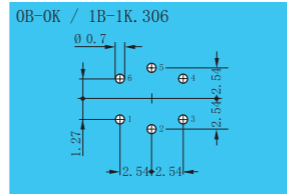
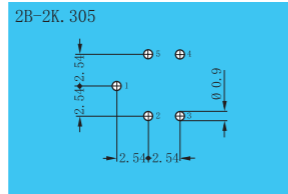
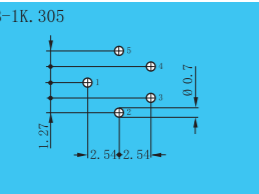
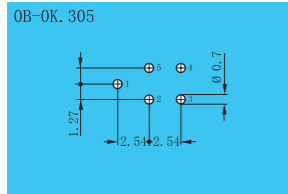

Elbow socket (90°) for printed circuit (B series)

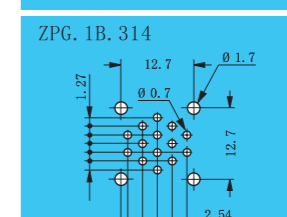
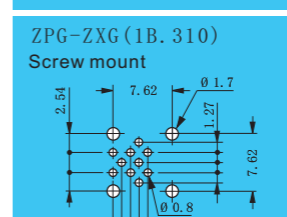
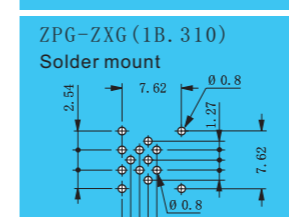
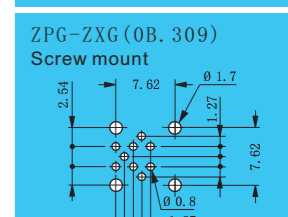
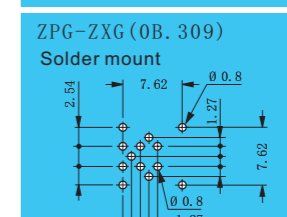
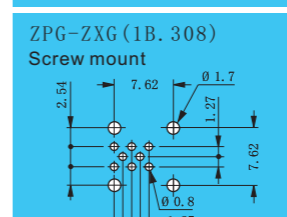
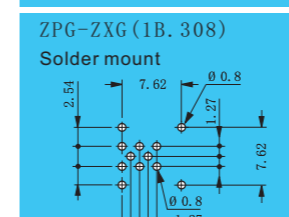
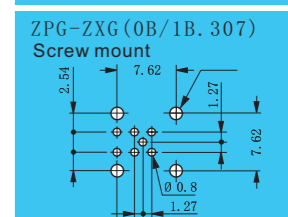
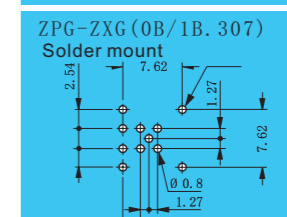
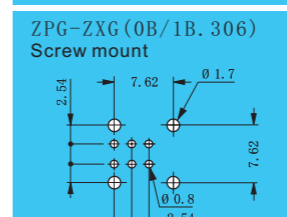
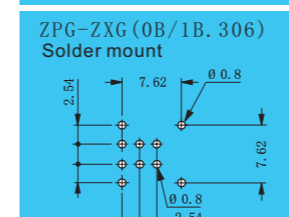
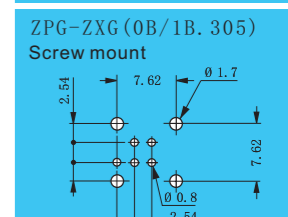
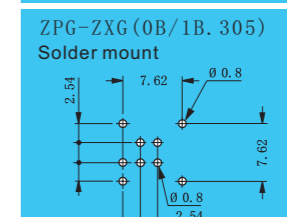
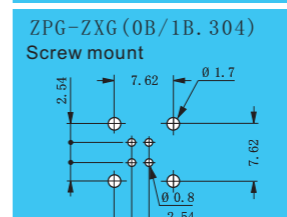
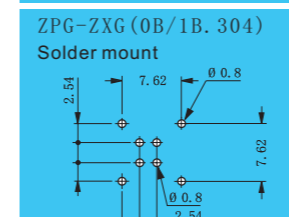
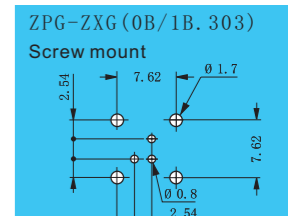
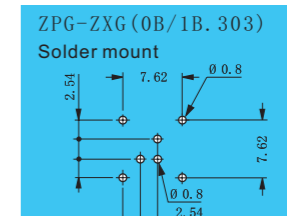
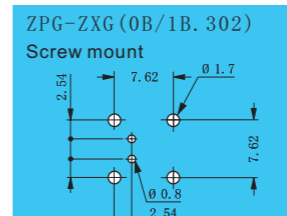
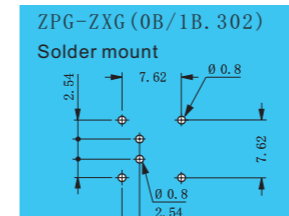
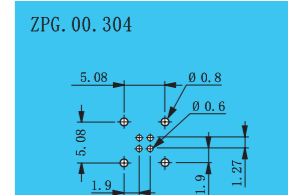
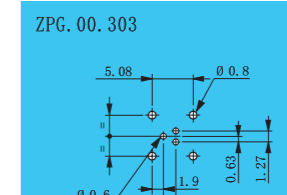
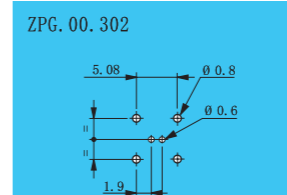
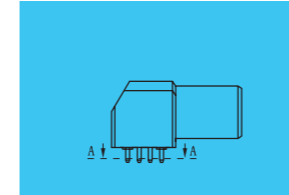

PCB drilling pattern

Fixed socket with straight print contact (S-E series)

302		Series	Dimensions(mm)	
		0S-0E	0.6	2.2
1S-1E	0.8	3.0		

303		Series	Dimensions(mm)		
		0S-0E	0.6	2.8	45°
1S-1E	0.8	3.5	45°		
2S-2E	0.8	5.5	60°		

304		Series	Dimensions(mm)		
		0S-0E	0.6	2.8	45°
1S-1E	0.8	3.5	45°		
2S-2E	0.8	5.0	45°		

305		Series	Dimensions(mm)			
		1S-1E	0.8	3.5	60°	45°
2S-2E	0.8	5.5	60°	60°		

306		Series	Dimensions(mm)		
		1S-1E	0.8	3.5	60°
2S-2E	0.8	5.5	60°		
3S-3E	0.8	6.5	60°		

307		Series	Dimensions(mm)				
		2S-2E	45°	22°30'	2.75	3.25	
3S-3E	45°	22°30'	3.25	3.90			

308		Series	Dimensions(mm)			
		2S-2E	0.8	6.5	45°	22°30'
3S-3E	0.8	7.8	45°	22°30'		

310		Series	Dimensions(mm)				
		2S-2E	0.8	6.5	45°	22°30'	1.25
3S-3E	0.8	7.8	45°	22°30'	1.50		

3S-3E. 312		Series	Dimensions(mm)	
		0S-0E	0.6	2.2
1S-1E	0.8	3.0		

3S-3E. 313		Series	Dimensions(mm)	
		0S-0E	0.6	2.2
1S-1E	0.8	3.0		

3S-3E. 314		Series	Dimensions(mm)	
		0S-0E	0.6	2.2
1S-1E	0.8	3.0		

3S-3E. 316		Series	Dimensions(mm)	
		0S-0E	0.6	2.2
1S-1E	0.8	3.0		

Note: all views are from the side of the socket.

Fixed socket with elbow print contact (S-E series)

302		Series	Dimensions (mm)	
		0S-0E	0.7	
1S-1E	0.9			

303		Series	Dimensions(mm)		
		0S-0E	0.7	2.00	1.00
1S-1E	0.7	2.48	1.24		

304		Series	Dimensions(mm)	
		0S-0E	0.7	2.00
1S-1E	0.7	3.50		
2S-2E	0.9	3.50		

305		Series	Dimensions (mm)	
		1S-1E	0.7	
2S-2E	0.9			

306		Series	Dimensions (mm)	
		1S-1E	0.7	
2S-2E	0.9			

2S-2E. 307		Series	Dimensions(mm)	
		0S-0E	0.6	2.2
1S-1E	0.8	3.0		

2S-2E. 308		Series	Dimensions(mm)	
		0S-0E	0.6	2.2
1S-1E	0.8	3.0		

2S-2E / 3S-3E. 310		Series	Dimensions(mm)	
		0S-0E	0.6	2.2
1S-1E	0.8	3.0		

3S-3E. 312		Series	Dimensions(mm)	
		0S-0E	0.6	2.2
1S-1E	0.8	3.0		

3S-3E. 314		Series	Dimensions(mm)	
		0S-0E	0.6	2.2
1S-1E	0.8	3.0		

3S-3E. 316		Series	Dimensions(mm)	
		0S-0E	0.6	2.2
1S-1E	0.8	3.0		

Elbow socket (90°) for printed circuit (S series)

P22 -ZPL-ZXP		Series	Dimensions(mm)	
		0S-0E	0.6	2.2
1S-1E	0.8	3.0		

P22 -ZPL-ZXP		Series	Dimensions(mm)	
		0S-0E	0.6	2.2
1S-1E	0.8	3.0		

P23 -ZPL. 00. 113		Series	Dimensions(mm)	
		0S-0E	0.6	2.2
1S-1E	0.8	3.0		

P23 -ZPL. 0S. 116		Series	Dimensions(mm)	
		0S-0E	0.6	2.2
1S-1E	0.8	3.0		

Note: all dimensions are in millimeters(mm).

Collets

D and M type collets for B series

Reference		Collet ϕ		Cable ϕ	
Type	Code	ΦA	ΦB	max.	min.
00	D 27	2.7	-	2.6	2.1
0B	D 32	3.2	-	3.0	2.1
	D 42	4.2	-	4.0	3.1
	D 52	5.2	4.7	5.0	4.1
1B	M 31	3.1	-	3.0	2.6
	D 42	4.2	-	4.0	3.1
	D 52	5.2	-	5.0	4.1
	D 62	6.2	-	6.0	5.1
	D 72	7.2	6.7	7.0	6.1
2B	M 42	4.2	-	4.0	3.1
	D 52	5.2	-	5.0	4.1
	D 62	6.2	-	6.0	5.1
	D 72	7.2	-	7.0	6.1
	D 82	8.2	-	8.0	7.1
	D 92	9.2	8.6	9.0	8.1
	D 99	9.9	8.6	9.7	9.1

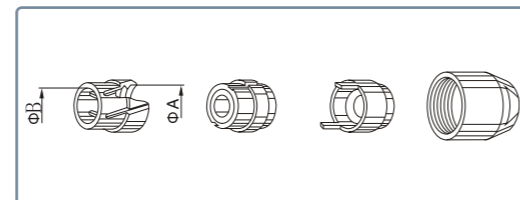
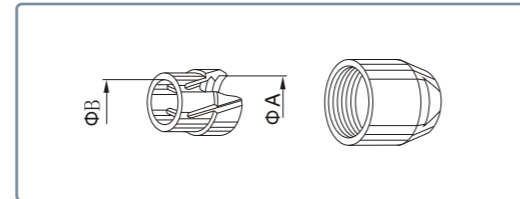

C and K type collets for K series

Reference		Collet ϕ		Cable ϕ	
Type	Code	ΦA	ΦB	max.	min.
0K	C 30	3.1	-	3.0	2.6
	C 40	4.2	4.2	4.0	3.6
	C 45	5.2	5.2	4.5	4.1
	C 50	5.2	5.2	5.0	4.6
1K	C 45	5.2	-	4.5	4.1
	C 50	5.2	-	5.0	4.6
	C 55	6.2	6.2	5.5	5.1
	C 60	6.2	6.2	6.0	5.6
	K 70	7.2	-	7.0	6.6
2K	C 65	7.2	-	6.5	6.1
	C 70	7.2	-	7.0	6.6
	C 85	9.2	8.6	8.5	8.1
	K 11	11.2	10.6	10.5	10.1

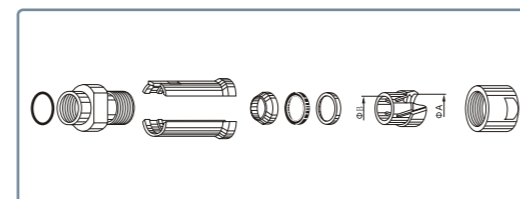
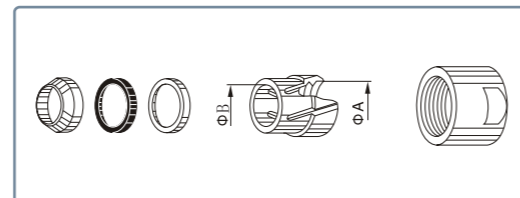

C, K and L type collets for S series

Reference		Collet ϕ		Cable ϕ	
Type	Code	ΦA	ΦB	max.	min.
00	C 27	2.7	-	2.6	2.2
	K 37	3.7	-	3.6	3.0
0S	C 27	2.7	-	2.6	2.2
	C 32	3.2	-	3.1	2.7
	C 42	4.2	3.7	4.1	3.3
	K 47	4.7	-	4.6	3.8
1S	C 32	3.2	-	3.1	2.6
	C 42	4.2	-	4.1	3.3
	C 47	4.7	-	4.6	3.8
	C 52	5.2	-	5.1	4.3

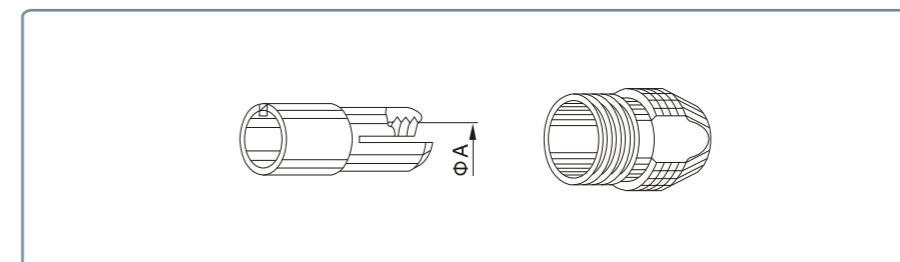
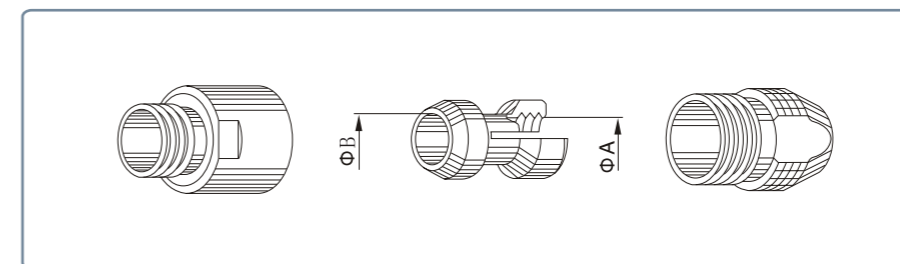
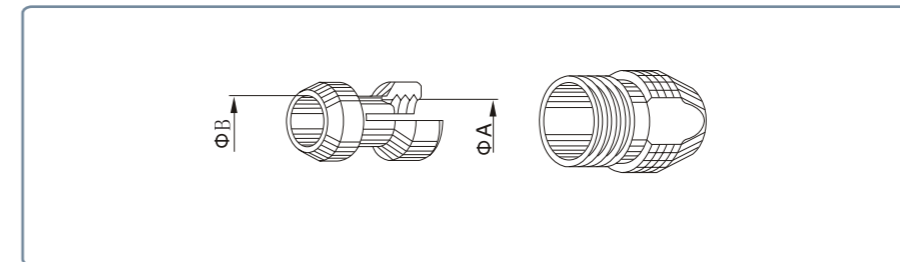

Accessories

BRF Socket caps for B series

- Shell material: brass chrome plated
- Lanyard material: stainless steel
- O-ring: silicone rubber
- Maximum operating temperature: 135°C
- Waterproof grade: IP50

Part number	Series	Dimensions (mm)				
		A	B	L	M	N
BRF.0B.200	0S-0B	10	9.5	10.5	4.5	85
BRF.1B.200	1S-1B	14	11.0	12.5	5.0	85
BRF.1B.200	2S-2B	18	12.0	14.0	6.0	85

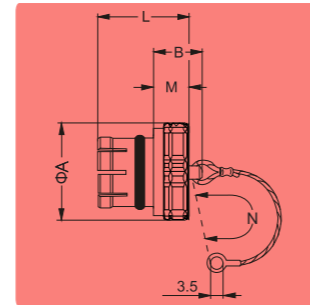

BFG Plug caps for B series, with key (G)

- Shell material: brass chrome plated
- Lanyard material: stainless steel
- O-ring: silicone rubber
- Maximum operating temperature: 135°C
- Waterproof grade: IP50

Part number	Series	Dimensions (mm)				
		A	B	L	M	N
BFG.0B.100	0S-0B	9.5	4.7	12.3		85
BFG.1B.100	1S-1B	11.8	6.2	13.8		85
BFG.2B.100	2S-2B	14.9	6.0	13.1		85

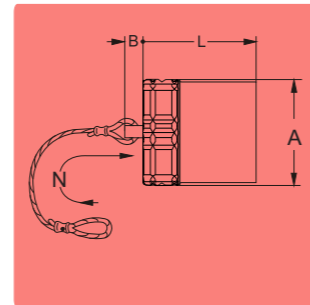

BRF Socket caps for K series

- Shell material: brass chrome plated
- Lanyard material: stainless steel
- O-ring: silicone rubber
- Maximum operating temperature: 135°C
- Waterproof grade: IP65~68

Part number	Series	Dimensions (mm)				
		A	B	L	M	N
BRF.0K.200.NAS	0K	15.0	10	15.0	4	85
BRF.1K.200.NAS	1K	17.0	12	20.0	6	85
BRF.2K.200.NAS	2K	20.5	14	24.0	8	85

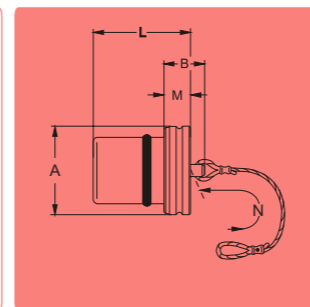

BFG Plug caps for K series, with key (G)

- Shell material: brass chrome plated
- Lanyard material: stainless steel
- O-ring: silicone rubber
- Maximum operating temperature: 135°C
- Waterproof grade: IP65~68

Part number	Series	Dimensions (mm)			
		A	B	L	N
BFG.0K.100.NAS	0K	14.0	6	12.5	85
BFG.1K.100.NAS	1K	16.0	6	15.5	85
BFG.2K.100.NAS	2K	19.5	6	17.5	85

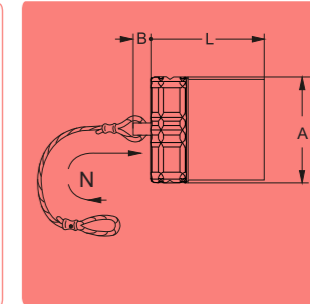

BRF Socket caps for T series

- Shell material: brass chrome plated
- Lanyard material: stainless steel
- O-ring: silicone rubber
- Maximum operating temperature: 135°C
- Waterproof grade: IP65~68

Part number	Series	Dimensions (mm)				
		A	B	L	M	N
BRF.0T.200	0T-0B	9	7.7	12.7	2.7	85
BRF.1T.200	1T-1B	12	9.5	14.4	3.5	85
BRF.2T.200	2T-2B	15	10.4	16.3	4.4	85

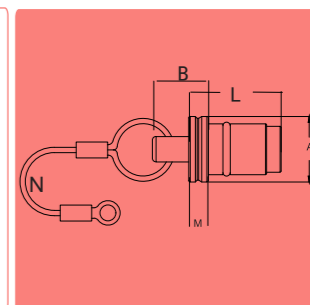

BFG Plug caps for T series, with key (G)

- Shell material: brass chrome plated
- Lanyard material: stainless steel
- O-ring: silicone rubber
- Maximum operating temperature: 135°C
- Waterproof grade: IP65~68

Part number	Series	Dimensions (mm)			
		A	B	L	N
BRG.0T.100	0T-0B	9	5.0	11.0	85
BRG.1T.100	1T-1B	12	6.0	12.4	85
BRG.2T.100	2T-2B	15	6.0	13.8	85

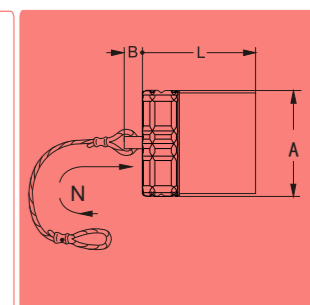

GRA Insulating washers(color wheel)

Sockets or plugs mounted on panels can be fitted with insulating washers.

Part number	Series	Dimensions (mm)			
		A	B	C	D
GRA.0B.269.GG	0S-0B	11.6	9.2	8.3	1.1
GRA.1B.269.GG	1S-1B	15.6	12.2	10.7	1.1
GRA.2B.269.GG	2S-2B	20.6	15.2	14.2	1.3
GRA.3B.269.GG	3S-3B	24.6	18.2	17.2	1.3

Ref.	Color	Ref.	Color
A	blue	N	black
B	white	R	red
G	grey	S	orange
J	yellow	V	green
M	brown		

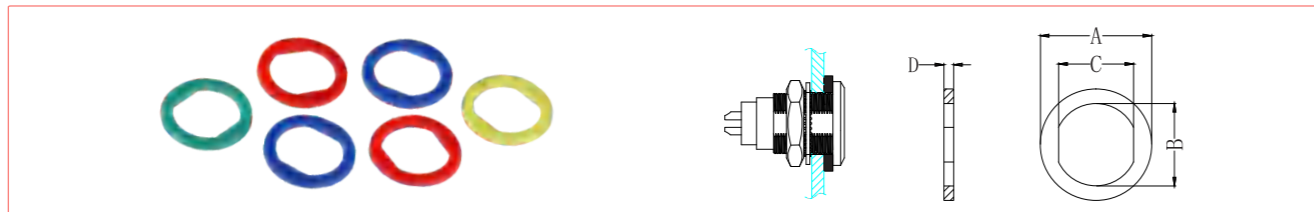

GM- Bend relief(PU)

The bend relief is made of polyurethane material, abbreviated PU. PU contains strong polar carbamate group, insoluble in non-polar groups, has good oil resistance, toughness, wear resistance, aging resistance and adhesion. Can be installed in ZHJM plug and socket, protect the cable.

Temperature range in dry atmosphere: -40°C, +80°C

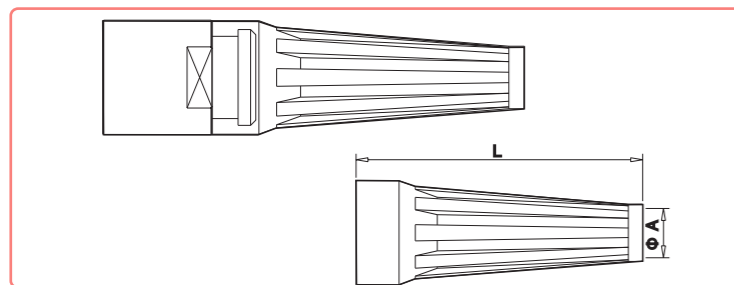

Series	Part number	Dimensions (mm)			
		Bend relief		Cable ø	
		A	L	max.	Min
00	GMA.00.028.DG	2.8	22	3.1	2.8
0B 0S	GMA.0B.030.DG	3.0	24	3.4	3.0
	GMA.0B.040.DG	4.0	24	4.4	4.0
	GMA.0B.045.DG	4.5	24	5.2	4.5
	GMA.0B.052.DG	5.2	24	5.6	4.5
	1B 1S	GMA.1B.040.DG	4.0	30	4.4
GMA.1B.045.DG		4.5	30	4.9	4.5
GMA.1B.054.DG		5.4	30	6.0	5.4
GMA.1B.065.DG		6.5	30	7.0	6.5
2B	GMA.2B.050.DG	5.0	36	5.5	5.0
	GMA.2B.060.DG	6.0	36	6.5	6.0
	GMA.2B.070.DG	7.0	36	7.7	7.0
	GMA.2B.080.DG	7.8	36	8.8	7.8

Ref.	Color	Ref.	Color
A	blue	N	black
B	white	R	red
G	grey	S	orange
J	yellow	V	green
M	brown		



Plug assembly Instructions

B series straight plug

1. Pass the cable through the bend relief(1), the collet nut(2) and the collet(3), and solder the cable to the insulator(5) assembly in accordance with the sequence;
2. Install the split insert carrier(4) on the soldered insulator(5) assembly. Note that the window on the split insert carrier(4) corresponds to the bulge on the insulator(5) assembly;
3. Clamp the collet(3) to the appropriate position of the cable, and pay attention to the bulge on the collet(3) corresponding to the groove on the insulator(4) clasp;
4. Push the insulator(5) assembly, insulator(4) and collet(3) into the plug assembly in turn, and pay attention to the bulge on the insulator(4) clasp corresponding to the gap in the outer shell(6) assembly;
5. Tighten the collet nut(2) to the outer shell(6) assembly;
6. Put the bend relief(1) on the corresponding step of the collet nut(2).

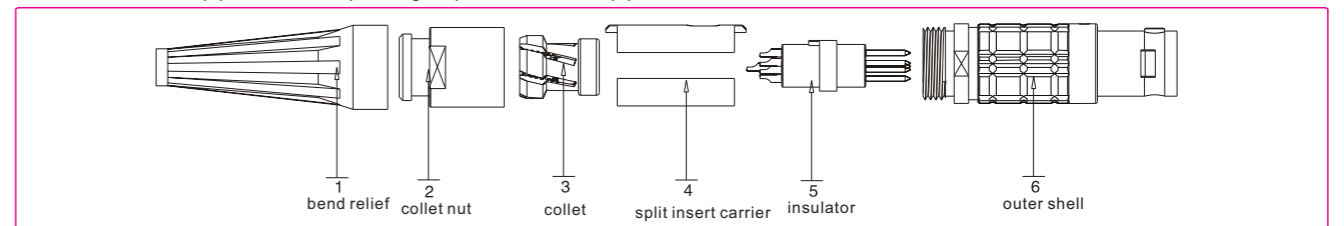

K series straight plug

1. Pass the cable through the bend relief(1), the collet nut(2), the collet(3), the V gasket(4), the o-ring(5) and the retaining ring(6), and solder the cable to the insulator(8) assembly in accordance with the sequence;
2. Install the split insert carrier(7) on the soldered insulator(8) assembly. Note that the window on the split insert carrier(7) corresponds to the bulge on the insulator(8) assembly, push retaining ring(6), o-ring(5), V gasket(4), collet(3) in turn to the appropriate position, to ensure that the complete skin of the cable inserted into retaining ring(6);
3. Insert the installed insulator(8) into outer shell(9), noting that the notch in split insert carrier(7) corresponds to the bulge in outer shell(9);
4. Tighten the collet nut(2) to the outer shell(9) assembly;
5. Put the bend relief(1) on the corresponding step of the collet nut(2).

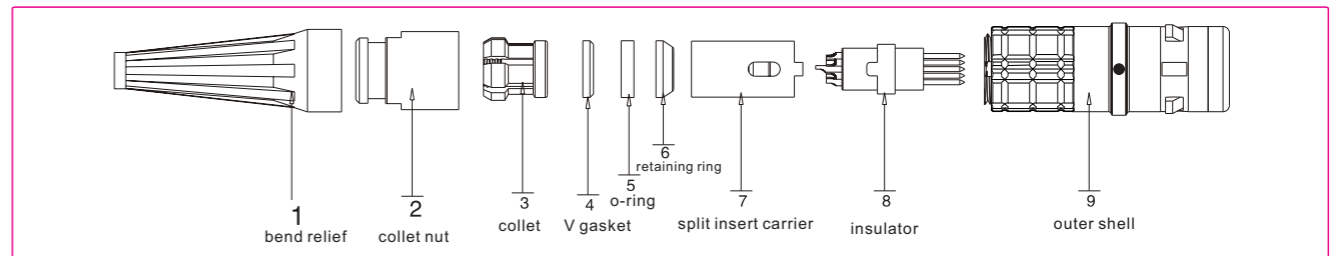

P series straight plug

1. Pass the cable through the collet nut(1), the collet(2), and solder the cable to the insulator(3) assembly in accordance with the sequence;
2. Install the collet(2) on the soldered insulator(3) assembly. Note that the bump in collet(2) corresponds to the notch in insulator(3);
3. Mount the insulator(3) components into outer shell(4), noting that the bulge on collet(2) is mounted to correspond to the groove in outer shell(4);
4. Insert collet nut(1) into outer shell(4), tighten the collet nut(1).

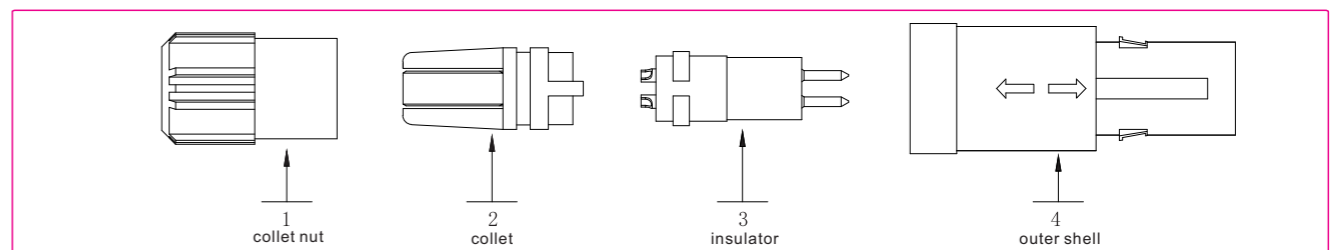

T series straight plug

1. Pass the cable through the bend relief(1), the collet nut(2), the collet(3), the V gasket(4), the o-ring(5) and the retaining ring(6), and solder the cable to the insulator(8) assembly in accordance with the sequence;
2. Install the split insert carrier(7) on the soldered insulator(8) assembly. Note that the window on the split insert carrier(7) corresponds to the bulge on the insulator(8) assembly, push retaining ring(6), o-ring(5), V gasket(4), collet(3) in turn to the appropriate position, to ensure that the complete skin of the cable inserted into retaining ring(6);
3. Insert the installed insulator(8) into outer shell(9), noting that the notch in split insert carrier(7) corresponds to the bulge in outer shell(9);
4. Tighten the collet nut(2) to the outer shell(9) assembly;
5. Put the bend relief(1) on the corresponding step of the collet nut(2).

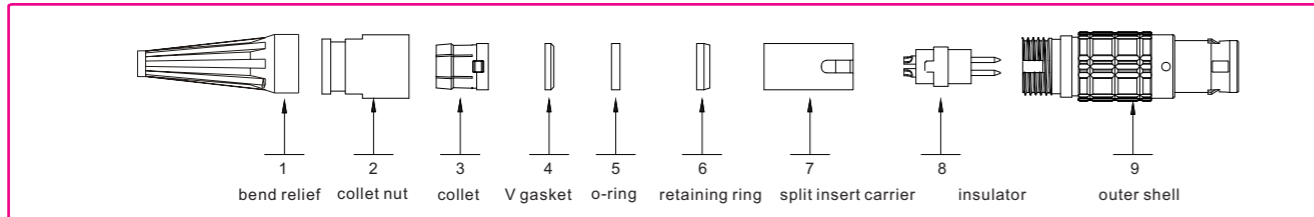

F series straight plug

1. Pass the cable through the bend relief(1), the collet nut(2), the collet(3), the V gasket(4), the o-ring(5) and the retaining ring(6), and solder the cable to the insulator(8) assembly in accordance with the sequence;
2. Install the split insert carrier(7) on the soldered insulator(8) assembly. Note that the window on the split insert carrier(7) corresponds to the bulge on the insulator(8) assembly, push retaining ring(6), o-ring(5), V gasket(4), collet(3) in turn to the appropriate position, to ensure that the complete skin of the cable inserted into retaining ring(6);
3. Insert the installed insulator(8) into outer shell(9), noting that the notch in split insert carrier(7) corresponds to the bulge in outer shell(9);
4. Tighten the collet nut(2) to the outer shell(9) assembly;
5. Put the bend relief(1) on the corresponding step of the collet nut(2).

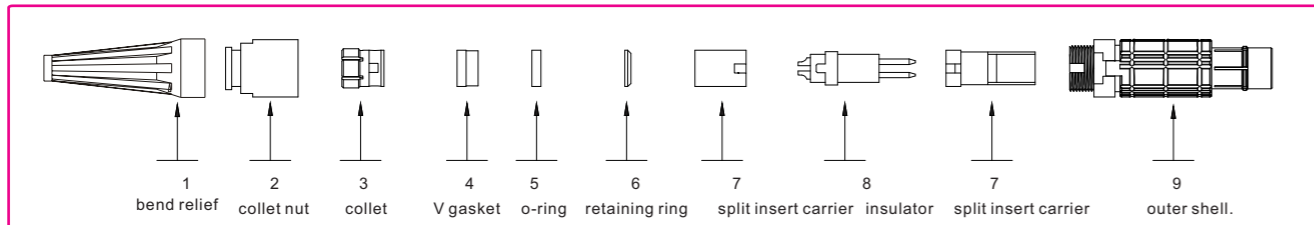

S series straight plug

1. Pass the cable through the bend relief(1), the collet nut(2) and the collet(3), and solder the cable to the insulator(5) assembly in accordance with the sequence;
2. The assembled components are pushed into outer shell(6);
3. Tighten the collet nut(2) to the outer shell(6) assembly;
4. Put the bend relief(1) on the corresponding step of the collet nut(2).

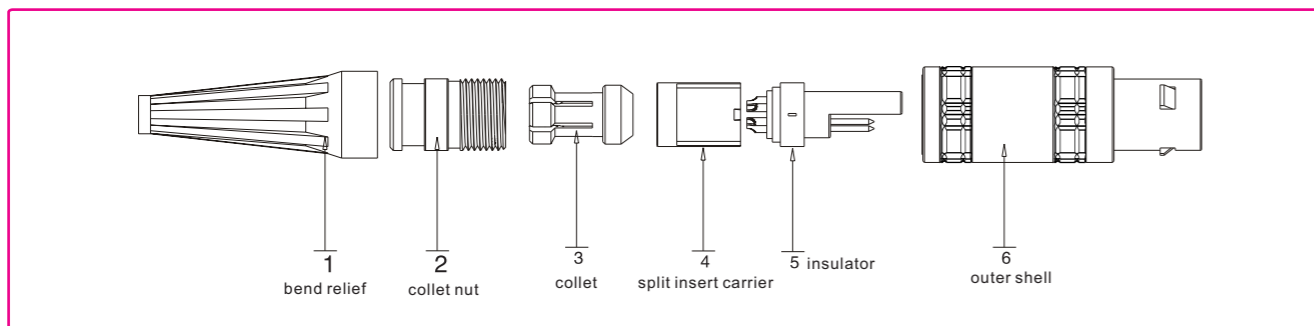

Coaxial connector

Series	Ref.	Contact type	Test voltage	Rated current	Contact ø	Shell size
00S	107	solder	1000V	7A	0.7mm	Refer to the S series TFA straight plug and ZRA socket
0S	113	solder	1200V	8A	1.3mm	
	116	solder	1500V	12A	1.6mm	
1S	113	solder	800V	8A	1.3mm	
	116	solder	1500V	12A	1.6mm	
	120	solder	1500V	12A	2.0mm	
2S	250	solder	1700V	18A	2.0mm	
0F	113	solder	1200V	8A	1.3mm	Refer to the 0F series
1W	116	solder	1500V	12A	1.6mm	Refer to the 1W series
1E	116	solder	1500V	12A	1.6mm	Refer to the 1K series



Panel cut-outs

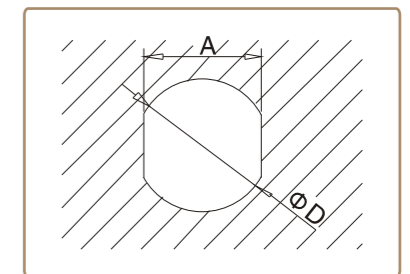

	A	00	0B	1B	2B	3B	4B	0K	1K	2K	3K	0S	1S	2S
A		6.3	8.3	10.6	13.6	16.6	23.5	12.5	14.6	18.6	22.5	8.3	10.6	13.5
D		7.1	9.1	12.1	15.1	18.1	25.1	14.1	16.1	20.1	24.1	9.1	12.1	15.1

PCB drilling pattern

Fixed socket with straight print contact (S series)

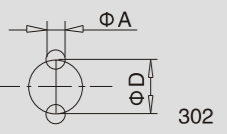
Contact NO.	Type	OS	1S
 302	A	0.8	0.8
	D	2.2	3.0
 304	A	0.8	0.8
	D	2.8	3.5
 306	A		0.8
	D		3.5

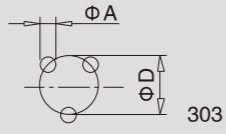
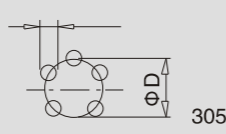
Contact NO.	Type	OS	1S
 303	A	0.8	0.8
	D	2.8	3.5
 305	A		0.8
	D		3.5

Wire harness machining scheme:

Cable harness processing:

Size	Straight plug			Elbow (90°) plug		
	L	A	S	L	A	S
00	5	2	2	11	2	2
0	7	2	2.5	16	2	2.5
1	9	2	2.5	18	2	2.5
2	11	2	2.5	27	2	2.5
3	13	2	2.5	30	2	2.5

Unit : mm, 公差 : +10% : Unit: mm, tolerance: +10%

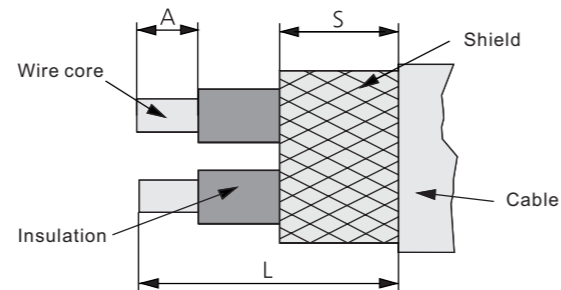

Matters needing attention in solder

- The outer diameter of the cable should match the size of the collet
- Contact specification should be in line with contact end diameter
- The temperature of the electric iron is controlled at about 380°C (lead-free)
- The single contact solder time is less than 1 second
- After solder, each contact should be covered with heat shrinkable tube insulation
- Pay attention to the protection of pins and insulators during solder.

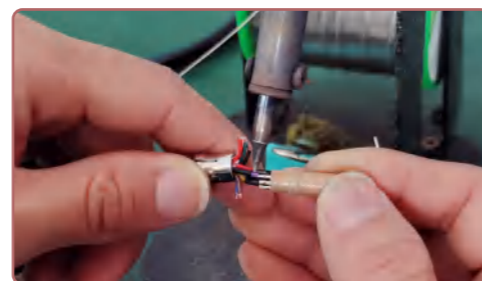

Cable processing application scheme



Harness display



Harness display



Testing and production equipment:

Precision wire testing machine:

Used to test short circuit, wrong line, insulation, withstand voltage, capacitance between lines of cable assembly; It can also test the secondary pipe of the component, resistance components, etc.



Injection molding machine:

Vertical mold locking, vertical injection, small footprint, dexterity and precision; Adopts computer control, each section temperature control, injection speed, back pressure can be infinitely adjusted. (Used for product and wire harness taping).



Wire stripping machine



Wire stripping machine



Winding machine



Integrated cutting and stripping machine

CNC machine tool



Line



Milling machine



Machining center

